

DS-1275ZJ-SUS

Horizontal Pole Mount

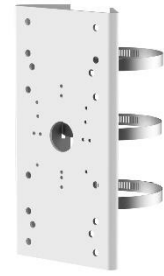

Feature

- Stainless steel with surface spray treatment
- One piece stainless steel formation ensures the reliable structure
- Adjustable diameter from 67 mm to 127 mm

Dimension

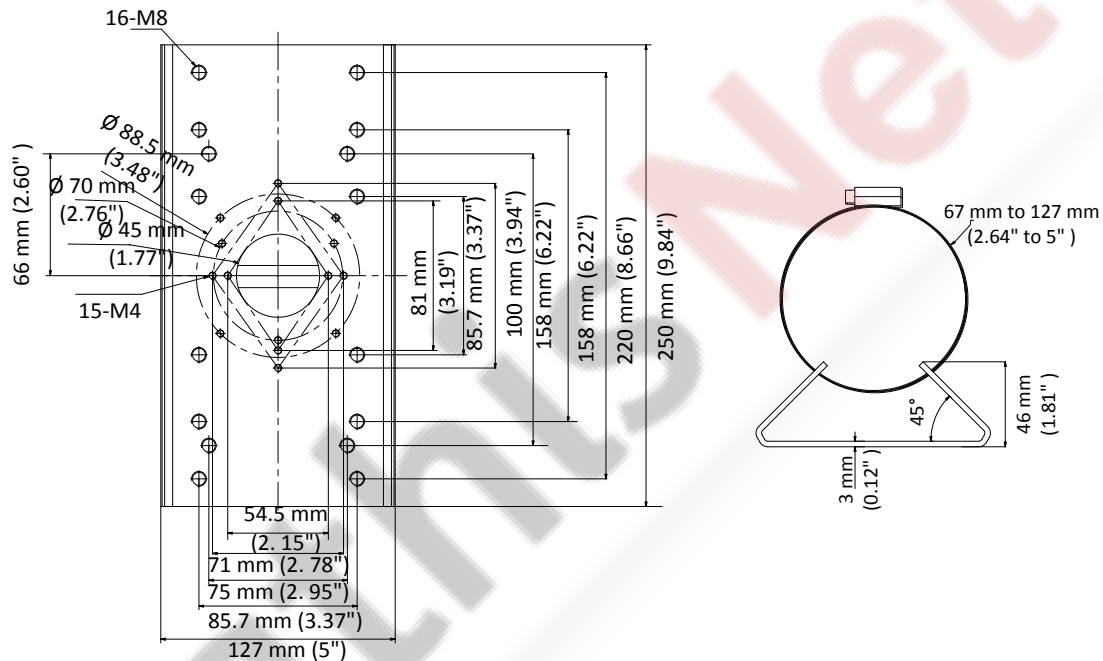

Available Model

DS-1275ZJ-SUS

Parameter

Model	DS-1275ZJ-SUS
Parameters	Horizontal Pole Mount
Appearance	Hikvision White
Material	Stainless Steel
Dimension	127 mm × 46 mm × 250 mm (5" × 1.81" × 9.84")
Weight	1400 g (3.09 lb.)

Note

- Cooperate with the pendant mount, when using this mount.
- The waterproof rubber is necessary for the outdoor application.
- The pole must be capable of supporting at least 3 times as much as the total weight of the camera, and the mount.
- The mount's maximum load capacity is 10 kg (22 lb.).