

## DS-1272ZJ-110

Wall Mounting Bracket for Dome Camera

### Features:

- Aluminum alloy material with surface spray treatment
- Exquisite cable entrance design
- Waterproof rubber blanket for outdoor application
- Convenient installation coordinating with adaptor

### Dimension:

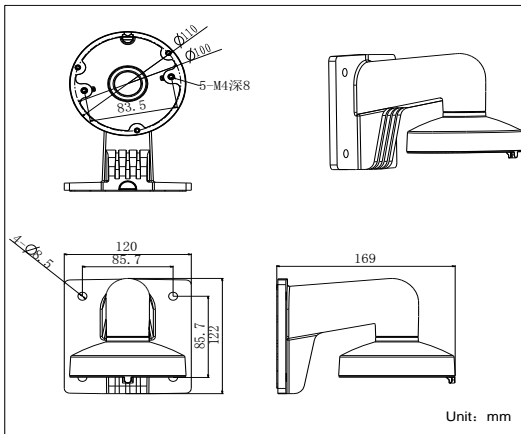

### Order Model:

DS-1272ZJ-110

### Parameter:

Model	DS-1272ZJ-110
Parameters	Wall Mounting Bracket for Dome Camera
Appearance	Hik White
Range of Application	Dome camera wall mounting
Material	Aluminum Alloy
Dimension	120×122×169mm
Weight	420g

### Notice:

- The bracket should be installed on flat wall
- The wall must be capable of supporting over 3 times as much as the total weight of the camera and the mount.
- The maximum load capacity of the bracket is 4.5KG

### Model Suitable:

DS-2CC51D3S-VPIR, DS-2CC52D5S-VPIR, DS-2CD2112(D)-(I)、DS-2CD2132(D)-(I)

### Installation Step:

- ① Choose appropriate wall to install the bracket and thread the cable

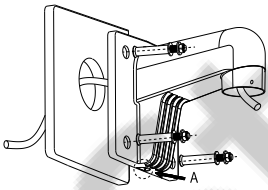

A: Cable entry hole

- ② Fix adaptor to bracket and thread the cable

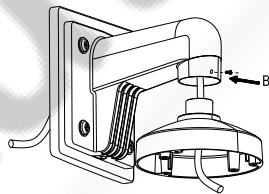

B: Fastening screw

- ③ Screw up and complete the fixation of adaptor

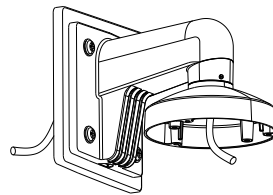

- ④ Take off lower dome, inner module and lining

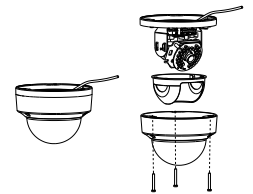

- ⑤ Complete wiring and fix dome module to cap

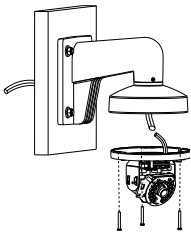

- ⑥ Fix the dome module and adjust the angle of view

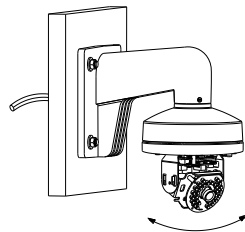

- ⑦ Install lining and lower dome to dome module and screw up

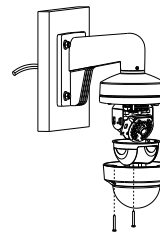

- ⑧ Installation complete

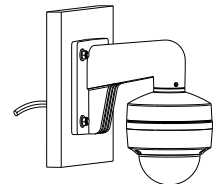

**Note:** The actual bracket may vary from the picture above.