

DS-2CE5AD3T-(A)VPIT3ZF 2 MP EXIR Dome Camera



Key Features

- 2 MP high-performance CMOS
- Ultra low light
- 1920 × 1080 resolution
- 2.7 mm to 13 mm motorized vari-focal lens, auto focus
- EXIR 2.0, smart IR, up to 70 m IR distance
- OSD menu, 3D DNR, 120 dB true WDR, day/night switch
- 4 in 1 video output (switchable TVI/AHD/CVI/CVBS)
- IP67, IK10
- Up the coax (HIKVISION-C)



Specifications

Camera	
Image Sensor	2.0 megapixel progressive scan CMOS
Signal System	PAL/NTSC
Video Frame Rate	PAL: 1080p@25fps NTSC: 1080p@30fps
Resolution	1920 (H) ×1080 (V)
Min. Illumination	0.005 Lux@(F1.2, AGC ON), 0 Lux with IR
Shutter Time	PAL: 1/25 s to 1/50, 000 s NTSC: 1/30 s to 1/50, 000 s
Lens	2.7 mm to 13.5 mm
Horizontal Field of View	102° to 31°
Lens Mount	Ø 14
Day & Night	IR cut filter
Angle Adjustment	Pan: 0° to 340°, Tilt: 0° to 75°, Rotation: 0° to 355°
Synchronization	Internal synchronization
WDR (Wide Dynamic Range)	≥ 120 dB
Menu	
AGC	High/Medium/Low
D/N Mode	Auto/Color/BW (Black and White)
Image Mode	STD/HIGH-SAT
HLC (Highlight Compensation)	Yes
BLC (Backlight Compensation)	Yes
WDR	Yes
3D DNR	Level 1 to 9
Language	English
Functions	Brightness, Sharpness, 3D DNR, Mirror, Smart IR
Interface	
Video Output	1 HD analog output
Switch Button	TVI/AHD/CVI/CVBS
General	
Operating Conditions	-40 °C to 60 °C (-40 °F to 140 °F), Humidity: 90% or less (non-condensation)
Power Supply	12 VDC ±25% -A: 24 VAC ±15%, 12 VDC ±20% <i>*You are recommended to use one power adapter to supply the power for one camera.</i>
Power Consumption	Max. 7.7 W -A: Max. 9.7 W
Protection Level	IP67, IK10
Material	Metal
IR Range	Up to 70 m
Dimensions	84.5 mm × 92 mm × 255.1 mm (3.33" × 3.62" × 10")
Weight	Approx. 830 g (1.83 lb.) -A: Approx. 870 g (1.92 lb.)

Order Model

DS-2CE5AD3T-VPIT3ZF, DS-2CE5AD3T-AVPIT3ZF

Dimension

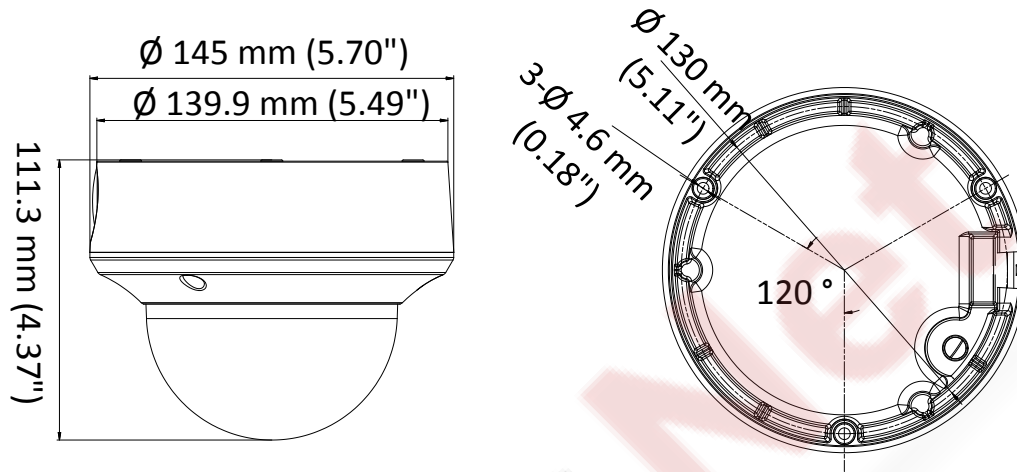

Accessory



DS-1273ZJ-140-DM45
Wall Mount

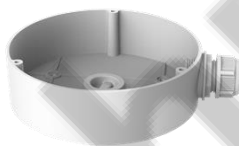

DS-1280ZJ-DM45
Junction Box

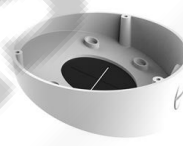

DS-1281ZJ-DM45
Inclined Ceiling Mount



DS-1271ZJ-140-DM45
Pendant Mount

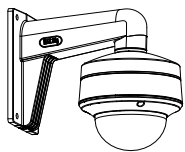

DS-1275ZJ-SUS
Vertical Pole Mount

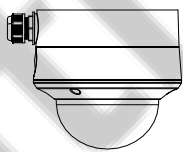

DS-1276ZJ-SUS
Corner Mount

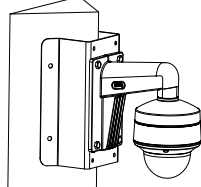
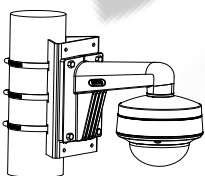

Distributed by

**HIKVISION®****Headquarters**

No.555 Qianmo Road, Binjiang District,
Hangzhou 310051, China
T +86-571-8807-5998
overseasbusiness@hikvision.com

Hikvision USA
T +1-909-895-0400
sales.usa@hikvision.com

Hikvision Australia
T +61-2-8599-4233
salesau@hikvision.com

Hikvision India
T +91-22-28469900
sales@pramahikvision.com

Hikvision Canada
T +1-866-200-6690
sales.canada@hikvision.com

Hikvision Thailand
T +662-275-9949
sales.thailand@hikvision.com

Hikvision Europe
T +31-23-5542770
sales.eu@hikvision.com

Hikvision Italy
T +39-0438-6902
info.it@hikvision.com

Hikvision Brazil
T +55 11 3318-0050
Latam.support@hikvision.com

Hikvision Turkey
T +90 (216)521 7070- 7074
sales.tr@hikvision.com

Hikvision Malaysia
T +601-7652-2413
sales.my@hikvision.com

Hikvision UK & Ireland
T +01628-902140
sales.uk@hikvision.com

Hikvision South Africa
Tel: +27 (10) 0351172
sale.africa@hikvision.com

Hikvision France
T +33(0)1-85-330-450
info.fr@hikvision.com

Hikvision Kazakhstan
T +7-727-9730667
nikia.panfilov@hikvision.ru

Hikvision Vietnam
T +84-974270888
sales.vt@hikvision.com

Hikvision UAE
T +971-4-4432090
salesme@hikvision.com

Hikvision Singapore
T +65-6684-4718
sg@hikvision.com

Hikvision Spain
T +34-91-737-16-55
info.es@hikvision.com

Hikvision Tashkent
T +99-87-1238-9438
uzb@hikvision.ru

Hikvision Hong Kong
T +852-2151-1761
info.hk@hikvision.com

Hikvision Russia
T +7-495-669-67-99
saleru@hikvision.com

Hikvision Korea
T +82-(0)31-731-8817
sales.korea@hikvision.com

Hikvision Poland
T +48-22-460-01-50
info.pl@hikvision.com

Hikvision Indonesia
T +62-21-2933759
Sales.Indonesia@hikvision.com

Hikvision Colombia
sales.colombia@hikvision.com