

# COMPACT HIGH POWER RELAY

## 1 POLE - 40A (For automotive applications)

### FBR53-HW Series

#### ■ FEATURES

- Small 40A relay
- High temperature grade (-40°C to 125°C)
- Contact arrangement Form U (form A)
- Surface mount compatible (reflow capability)
- Inrush current 80A
- Coil wire temperature class: H

#### ■ Part Numbers

[Example]    FBR53    N    D12    -    Y    -    HW    -    RW  
                   (a)        (b)        (c)        (d)        (e)        (f)

(a)	Relay type	FBR53	: FBR53 series
(b)	Enclosure	N	: Plastic sealed type
(c)	Coil rated voltage	D12	: 9...12VDC Coil rating table at page 3
(d)	Contact material	Y	: Silver-tin oxide
(e)	Contact rating	HW	: 40A
(f)	Soldering	Nil RW	: Standard (Flow soldering) : Reflow capable (THR)

Actual markings does not carry the type name: "FBR"  
 E.g.: Ordering code: FBR53ND12-Y-HW Actual marking: 53ND12-Y-HW



# FBR53-HW Series

## ■ Specifications

Item	FBR53-HW		Remarks / conditions	
Contact data	Configuration		1 form U	
	Material		Silver-tin oxide	
	Voltage drop		Max. 100 mV at 1A, 12VDC. Average 1.2mΩ at 7A, 12VDC	
	Contact rating		40A, 14VDC	Resistive load
	Max. carrying current		40A	
	Max. inrush current		80A	Reference
	Min. switching load		1A 6VDC	Reference *
Coil	Rated power consumption		860mW At 20°C	
	Operate power consumption		310mW At 20°C	
	Operating temperature range		-40°C ~ +125°C No frost	
Timing data	Operate		Max. 10ms At nominal voltage	
	Release		Max. 10ms At nominal voltage	
Life	Mechanical		Min. 1 x 10 <sup>6</sup> operations without contact load	
	Electrical		Min. 100 x 10 <sup>3</sup> operations 14VDC, 40A resistive load	
Insulation	Insulation resistance		Min. 100MΩ Initial	
	Dielectric withstanding voltage	Open contacts	500VAC (50/60Hz), 1 minute	
		Coil contact	500VAC (50/60Hz), 1 minute	
Other	Vibration resistance	Misoperation	10 to 200Hz, acceleration 44m/s <sup>2</sup> (4.4G) constant acceleration	
		Endurance	10 to 200Hz, acceleration 44m/s <sup>2</sup> (4.4G) constant acceleration	
	Shock resistance	Misoperation	100m/s <sup>2</sup> (11±1ms)	Direction X, Y, Z, contact ON/OFF total 36 times
		Endurance	1,000m/s <sup>2</sup> (6±1ms)	Direction X, Y, Z, contact OFF total 18 times
Dimensions / weight		12.3 x15.7x14.0 mm / approx. 6g		

\*: Minimum switching loads mentioned above are reference values. Please perform the confirmation test with actual load before production since reference values may vary according to switching frequencies, environmental conditions and expected reliability levels. Care shall be taken on the heat generated on PC board when maximum carrying current exceeds 10A. Please perform the confirmation test with actual conditions.

# FBR53-HW Series

## ■ Coil Data

Coil code	Rated Coil Voltage (VDC)	Coil Resistance +/-10% ( $\Omega$ )	Must Operate Voltage* (VDC)	Must Release Voltage* (VDC)
D09	9	94	5.4 7.7 (at 125°C)	0.7 1.0 (at 125°C)
D10	10	117	6.3 9 (at 125°C)	0.8 1.2 (at 125°C)
D12	12	167	7.3 10.4 (at 125°C)	1.0 1.5 (at 125°C)

Note: All values in the table are valid at 20°C and zero contact current, unless otherwise specified.

\*: Specified operated values are valid for pulse wave voltage.

Please use at rated coil voltage. Please refer to characteristic data and set up adequate voltage in case of use at over voltage.

## ■ Dimensions

### • Dimensions

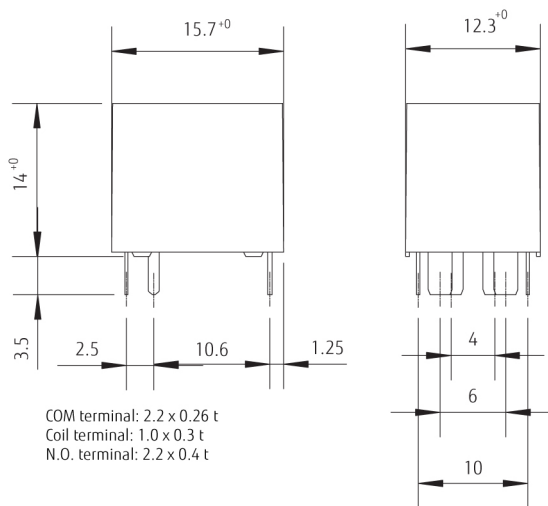

Dimensions of the terminals do not include thickness of pre-solder.

### • Schematics

#### (BOTTOM VIEW)

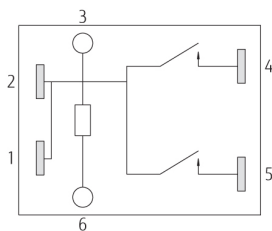

Pattern shall be designed to short-circuit #4 and #5 on the PC board.

# FBR53-HW Series

- PC Board Mounting Hole Layout (BOTTOM VIEW)

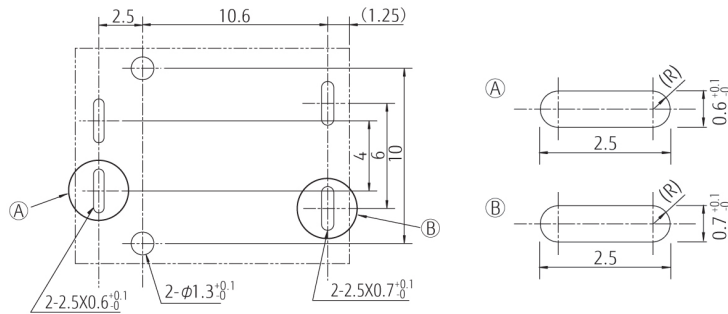

Tolerance of PC board mounting hole layout :  $\pm 0.1$  unless otherwise specified.

( ): Reference value  
Unit: mm

## ■ Characteristic Data (Reference)

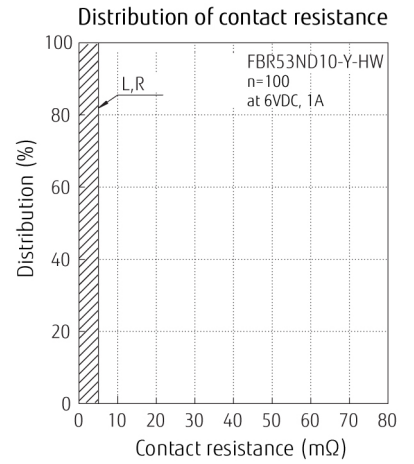
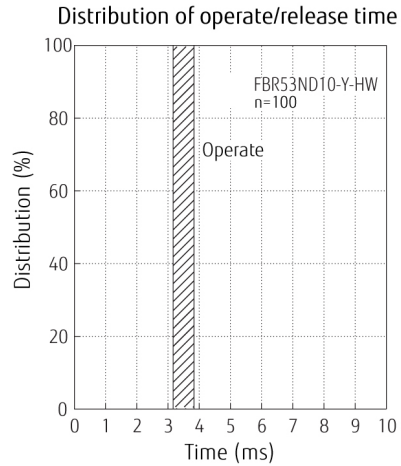
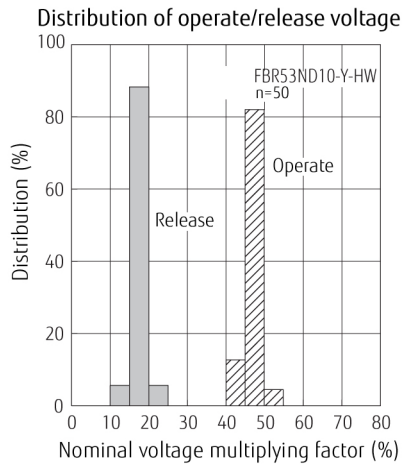

# FBR53-HW Series

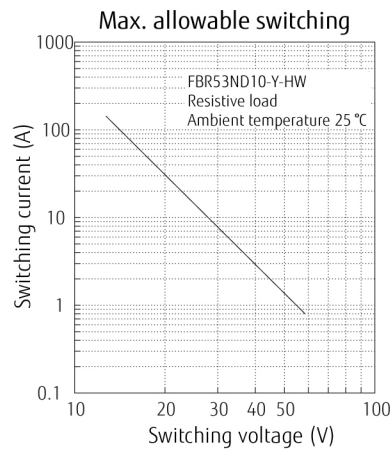
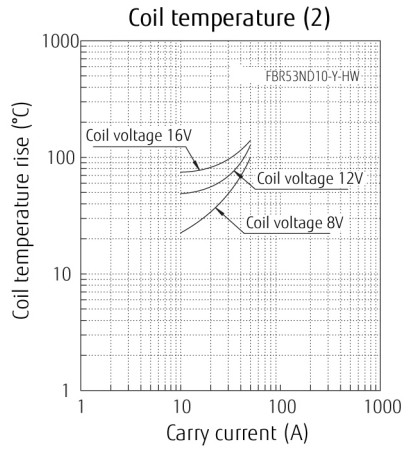
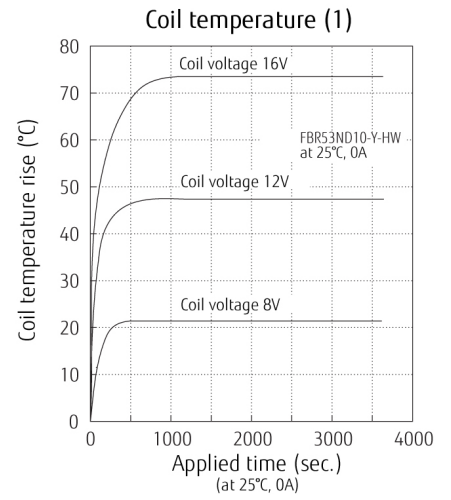
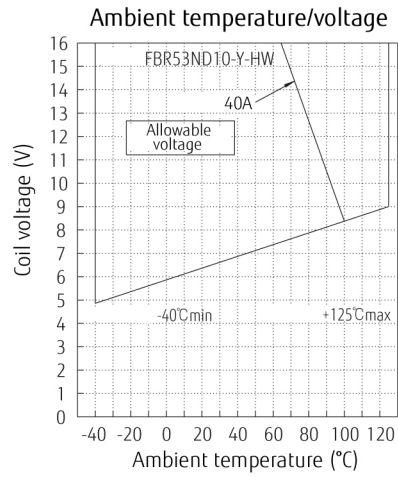
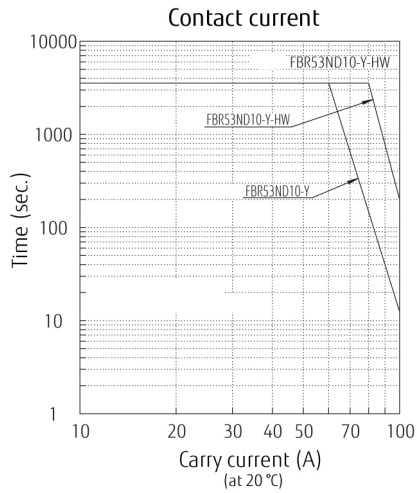

# FBR53-HW Series

## GENERAL INFORMATION

### 1. ROHS Compliance

- All relays produced by Fujitsu Components are compliant with RoHS directive 2011/65/EU including amendments.
- Use of Cadmium in electrical contacts is exempted as per Annex III of the RoHS directive 2001/65/EU. Please consider expiry date of exemption. Relays with Cadmium containing contacts are not to be used for new designs.
- All relays are lead-free. Please refer to Lead-Free Status Info for older date codes at: <http://www.fujitsu.com/downloads/MICRO/fcai/relays/lead-free-letter.pdf>

### 2. Recommended lead free solder condition

- Lead free solder plating on relay terminals is Sn-3.0Ag-0.5Cu, unless otherwise specified. This material has been verified to be compatible with PbSn assembly process.
- Recommended solder for assembly: Sn-3.0Ag-0.5Cu.

#### Flow Solder Condition:

Pre-heating: maximum 120°C within 90 sec.  
Soldering: dip within 5 sec. at 255°C ± 5°C solder bath  
Relay must be cooled by air immediately after soldering

#### Solder by Soldering Iron:

Soldering Iron 30-60W  
Temperature: maximum 350-360°C  
Duration: maximum 3 sec.

#### Recommended reflow soldering profile IRS (infrared reflow soldering)

Peak temperature: Max.250°C

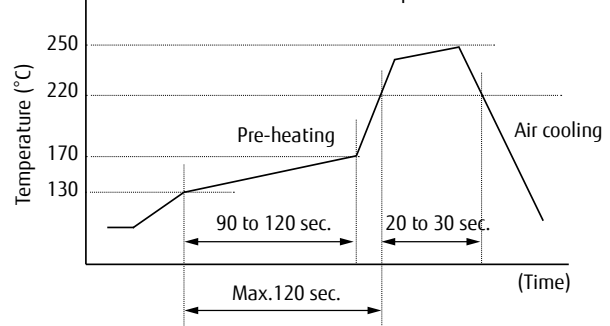

#### Important Notes for Reflow Soldering

- Temperature shall be measured at PC board upper surface.
- Temperature at PC board upper surface may be changed depending on size of PC board, components mounted on the PC board and/or heating method. Please perform the confirmation test with your actual PC boards.
- This reflow solder condition is applicable only for reflow-capable relays. Do not reflow reflow-incapable relays.
- Recommended solder for assembly: Sn-3.0 Ag-0.5 Cu.

**We highly recommend that you confirm your actual solder conditions**

### 3. Moisture Sensitivity

- Moisture Sensitivity Level standard is not applicable to electromechanical relays, unless otherwise indicated. -RW THR relay will be shipped in moisture barrier bag.

### 4. Tin Whiskers

- Dipped SnAgCu solder is known as presenting a low risk to tin whisker development. No considerable length whisker was found by our in house test.

# FBR53-HW Series

## Fujitsu Components International Headquarter Offices

<b>Japan</b> FUJITSU COMPONENT LIMITED Shinagawa Seaside Park Tower 19F, 12-4, Higashi-shinagawa 4-chome, Shinagawa-ku, Tokyo, 140-0002, Japan Tel: (81-3) 3450-1682 Fax: (81-3) 3474-2385 Email: fcl-contact@cs.jp.fujitsu.com Web: www.fujitsu.com/jp/fcl/	<b>Asia Pacific</b> FUJITSU COMPONENTS ASIA, LTD. 102E Pasir Panjang Road #01-01 Citilink Warehouse Complex Singapore 118529 Tel: (65) 6375-8560 Fax: (65) 6273-3021 Email: fcal@sg.fujitsu.com Web: www.fujitsu.com/sg/products/devices/components	<b>Korea</b> FUJITSU COMPONENTS KOREA LIMITED Alpha Tower #403, 645 Sampoong-dong, Bundang-gu, Seongnam-si, Gyeonggi-do, 13524 Korea Tel: (82) 31-708-7108 Fax: (82) 31-709-7108 Email: fcal@sg.fujitsu.com www.fujitsu.com/sg/products/devices/components/
<b>North and South America</b> FUJITSU COMPONENTS AMERICA, INC 2290 North First Street, Suite 212 San Jose, CA 95131, USA Tel: (1-408) 745-4900 Fax: (1-408) 745-4970 Email: components@us.fujitsu.com Web: us.fujitsu.com/components	<b>China</b> FUJITSU ELECTRONIC COMPONENTS (SHANGHAI) CO., LTD. Unit 4306, InterContinental Center 100 Yu Tong Road, Shanghai 200070, China Tel: (86-21) 3253 0998 Fax: (86-21) 3253 0997 Email: fcal@sg.fujitsu.com Web: www.fujitsu.com/sg/products/devices/components	
<b>Europe</b> FUJITSU COMPONENTS EUROPE B.V. Diamantlaan 25 2132 WV Hoofddorp Netherlands Tel: (31-23) 5560910 Fax: (31-23) 5560950 Email: info@fceu.fujitsu.com Web: www.fujitsu.com/uk/components	<b>Hong Kong</b> FUJITSU COMPONENTS HONG KONG CO., LTD Unit 506, Inter-Continental Plaza No.94 Granville Road, Tsim Sha Tsui, Kowloon, Hong Kong Tel: (852) 2881-8495 Tex: (852) 2894-9512 Email: fcal@sg.fujitsu.com Web: www.fujitsu.com/sg/products/devices/components/	

©2017 Fujitsu Components Europe B.V. All rights reserved. All trademarks or registered trademarks are the property of their respective owners.

The contents, data and information in this datasheet are provided by Fujitsu Component Ltd. as a service only to its user and only for general information purposes.

The use of the contents, data and information provided in this datasheet is at the users' own risk.

Fujitsu has assembled this datasheet with care and will endeavor to keep the contents, data and information correct, accurate, comprehensive, complete and up to date.

Fujitsu Components Europe B.V. and affiliated companies do however not accept any responsibility or liability on their behalf, nor on behalf of its employees, for any loss or damage, direct, indirect or consequential, with respect to this datasheet, its contents, data, and information and related graphics and the correctness, reliability, accuracy, comprehensiveness, usefulness, availability and completeness thereof.

Nor do Fujitsu Components Europe B.V. and affiliated companies accept on their behalf, nor on behalf of its employees, any responsibility or liability for any representation or warrant of any kind, express or implied, including warranties of any kind for merchantability or fitness for particular use, with respect to these datasheets, its contents, data, information and related graphics and the correctness, reliability, accuracy, comprehensiveness, usefulness, availability and completeness thereof. Rev. September 14<sup>th</sup>, 2017