

# V7 SERIES

004987

Issue 4

## MICRO SWITCH Premium Miniature Basic Switches

### DESCRIPTION

Honeywell's MICRO SWITCH V7 Series premium miniature basic switches have been designed for long-term reliability, up to 10 million cycles. These switches incorporate a snap-spring mechanism with more than 60 years of proven service and a high strength thermoplastic housing for durability. V7 Series switches are designed with a standard temperature rating of 85 °C (185 °F) or options for a temperature rating up to 175 °C (347 °F).

The switches are available with a single pole double throw (SPDT) or single pole single throw (SPST) contact design. Actuation for the switches includes a wide range of options, which include the pin plunger or an assortment of integral levers with two different lever locations. Design variations of the internal switch mechanism and contact materials permit these switches to reliably control logic level electrical loads from less than 0.1 A to power duty switching up to 25 A. Different styles of electrical terminals solve most installation parameters.

V7 Series miniature basic switches have been certified by CSA, CE and UL for global applications as well as being RoHS compliant. These switches are available through Honeywell's worldwide network.

### DIFFERENTIATION

- Wide assortment of actuators for the V7 switch, electrical terminations and operating characteristics to solve numerous switch applications
- V7 Series common package size offers different internal switch designs which can reliably control a wide range of electrical loads from logic level to power duty switching (up to 25 A)
- Honeywell worldwide network for product availability

### VALUE TO CUSTOMERS

- Wide variety of electrical ratings; 0.1 A up to 25 A
- Available with pin plungers or different styles of integral levers to integrate into equipment requirements
- Agency certified for global applications

### FEATURES

- High strength thermoplastic housing, glass-filled PCT high-performance polyester
- Single pole double throw (SPDT): 3 terminals; single pole single throw normally closed (SPST-NC) 2 terminals; or single pole single throw normally open (SPST-NO) 2 terminals
- Wide range of electrical ratings from logic level (less than 0.1 A) up to 25 A power duty rated
- Pin plunger actuated or wide assortment of factory assembled integral lever options
- Operate force range as low as 15 g (0.5 oz) up to 400 g (14 oz)
- Rated for up to 10 million cycles
- Temperature range from -40°C to 85°C [-40°F to 185°F] or options for -40°C to 175°C [-40°F to 347°F]
- Common V Series diagonal mounting pattern; 22,2 mm L x 10,3 mm H [0.88 L x 0.41 in H]
- CSA, ENEC, and UL certifications; RoHS compliant



### POTENTIAL APPLICATIONS

- Vending machines
- Household appliances
- Pressure switch assemblies
- Refrigeration and air-conditioning equipment\*

*\*An ignition-protected component does not necessarily comply with all the requirements of the components for use in hazardous locations as defined by ANSI/NFPA 70, National Electrical Code.*

### PORTFOLIO



Honeywell offers a wide range of MICRO SWITCH basic switches. These include the large basic switches, V Series basic switches, miniature basic switches, watertight switches and special duty basic switches.

To view the entire product portfolio, [click here](#).

**Honeywell**

# MICRO SWITCH PREMIUM BASIC SWITCHES, V7 SERIES

**TABLE 1. SPECIFICATIONS**

CHARACTERISTIC	PARAMETER
Circuitry	SPDT, SPNO, SPNC
Operating force	0,25 N to 3,9 N [15 g to 397 g]
Termination	quick connect; 4,75 mm x 0,51 mm [0,187 in x 0,02 in] quick connect; 6,35 mm x 0,81 mm [0,25 in x 0,032 in] PCB (printed circuit board)
Actuators	pin plunger, integral lever options
Agency certification	CSA, ENEC, UL; RoHS compliant
Operating temperature	-40°C to 85°C [-40°F to 185°F], options for 175°C [347°F]
Mechanical life (cycles)	up to 10 million cycles
Contact material	silver, gold plated, gold alloy
Housing material	glass-filled PCT high-performance polyester

**TABLE 2. ELECTRICAL RATINGS**

RATING CODE	UL, CSA	ENEC <sup>3</sup>
A	5 A 125 Vac, 250 Vac, 277 Vac 1/10 HP 250 Vac	3 (1) A, 250 Vac <sup>2</sup>
B	11 A 1/3 HP 125 Vac, 250 Vac or 277 Vac 1/2 A 125 Vdc; 1/4 A 250 Vdc 4 A 125 Vac "L" <sup>1</sup>	10 (3) A, 250 Vac <sup>2</sup>
C	15.1 A 1/2 HP 125 Vac, 250 Vac or 277 Vac 1/2 A 125 Vdc 1/4 A 250 Vdc; 5 A 125 Vac "L" <sup>1</sup>	–
E	10 A 1/3 HP 125 Vac, 250 Vac or 277 Vac 1/2 A 125 Vdc 1/4 A 250 Vdc, 4 A 125 Vac "L" <sup>1</sup>	5 (2) A, 250 Vac <sup>2</sup>
F	3 A 125 Vac, 250 Vac, 277 Vac 1/10 HP 250 Vac	–
S	0.1 A, 125 Vac <sup>4</sup>	1 (0.05) A, 250 Vac <sup>2</sup>
V	21 A 1 HP 125 Vac, 250 Vac, 277 Vac 2 HP 250 Vac, 277 Vac	16 (4) A, 250 Vac <sup>2</sup>
W	15.1 A 125 Vac, 250 Vac, 277 Vac	
Z	25 A, 277 Vac 1 HP, 125 Vac; 2 HP, 250 Vac	20 (5) A, 250 Vac <sup>2</sup>

<sup>1</sup>Incandescent lamp rating

<sup>2</sup>XX(Y) - XX = max. rated resistive value in amps, and (Y) = max. rated inductive value in amps

<sup>3</sup>European ENEC rating requires Mounting Construction code "9" or "0". See page 4, Mounting Construction column

<sup>4</sup>The 0.1A (S Code) design maintains ignition-protected components per UL NCKL2/8 certification for use in refrigeration and air-conditioning equipment

# MICRO SWITCH PREMIUM BASIC SWITCHES, V7 SERIES

FIGURE 1. PRODUCT NOMENCLATURE

Switch Type <sup>A</sup>	Operating Force	Electrical Rating <sup>C,F</sup>		Circuitry Code	Mounting/ Construction <sup>D,F</sup>	Termination Style (Inches)	Lever Style <sup>B</sup>	Special Designator
		North America	Europe (ENEC)					
<b>V7 Series Miniature</b>								
<b>1</b>	150 g max.	<b>A</b>	5 A @ 125 Vac 3 A	<b>1</b>	<b>3</b> 150 °C 2,9 mm [0.11 in] mtg. holes	<b>D8</b> 0.187 x 0.02 quick connect	<b>002</b> Straight 22,1 mm [0.87 in]	Use only if this switch has a special feature. Could be any number.
<b>1<sup>N</sup></b>	175 g max.	<b>B</b>	11 A @ 125 Vac 10 A	<b>2</b>	<b>4</b> 150 °C 3,1 mm [0.12 in] mtg. holes	<b>E8</b> 0.187 x 0.02 quick connect spread	<b>022</b> Straight 35,6 mm [1.4 in]	
<b>1<sup>P</sup></b>	225 g max.	<b>C<sup>K</sup></b>	15 A @ 125 Vac —	<b>3</b>	<b>7</b> 85 °C 2,9 mm [0.11 in] mtg. holes	<b>D9</b> 0.250 x 0.032 quick connect	<b>201</b> Roller 20,6 mm [0.81 in]	
<b>2<sup>G</sup></b>	75 g max.	<b>D</b>	1 A @ 125 Vac 1 A		<b>8</b> 85 °C 3,1 mm [0.12 in] mtg. holes	<b>E9</b> 0.250 x 0.032 quick connect spread	<b>207</b> Roller 34,0 mm [1.34 in]	
<b>3<sup>H</sup></b>	50 g max.	<b>E</b>	10 A @ 125 Vac 5 A		<b>9<sup>F</sup></b> 85 °C 2,9 mm [0.11 in] mtg. holes	<b>P02</b> Left angle PCB	<b>263</b> Sim. roller 32,8 mm [1.29 in]	
<b>4<sup>I</sup></b>	25 g max.	<b>F</b>	3 A @ 125 Vac —		<b>0<sup>F</sup></b> 85 °C 3,1 mm [0.12 in] mtg. holes	<b>P07</b> SPNO on edge PCB	<b>266</b> Tall sim. roller 34,0 mm [1.34 in]	
<b>5<sup>J</sup></b>	15 g max.	<b>H</b>	No rating —		<b>A<sup>E</sup></b> 177 °C with 2,9 mm [0.11 in] mtg. holes	Formed quick-connect terminals available	<b>048</b> Straight 59,4 mm [2.34 in]	
<b>6</b>	6 oz to 14 oz max.	<b>K</b>	22 A @ 125 Vac 20 A				<b>636</b> Paddle 139,5 mm [5.5 in]	
<b>7</b>	8 oz max.	<b>S<sup>L</sup></b>	0.1 A @ 125 Vac 1 A					
<b>9</b>	300 g max.	<b>V</b>	21 A @ 125 Vac 16 A					
		<b>W<sup>E,M</sup></b>	15.1 A @ 125 Vac —					
		<b>X<sup>E,K</sup></b>	6 A @ 125 Vac —					
		<b>Z</b>	25 A @ 125 Vac 20 A					

**ONLY**

NOTES:  
<sup>A</sup> Not all possible combinations are available, these are only guidelines  
<sup>B</sup> Lever length measured from center of back mounting hole to end of straight lever or center of roller  
<sup>C</sup> All ratings are UL/CSA, and where noted are also European-rated ENEC  
<sup>D</sup> Consider the temperature required and the mounting hole size when making this selection  
<sup>E</sup> Electric ratings "W" and "X" only used with "A" Mounting Construction and vice versa  
<sup>F</sup> European ENEC rating requires Mounting Construction code "9" or "0", and Electrical Ratings A,B,D,E,K,S,V,Z  
<sup>G</sup> Not applicable for Electrical Ratings C,K,V,W,X,Z  
<sup>H</sup> Not applicable for Electrical Ratings B,C,K,V,W,X,Z  
<sup>I</sup> Applies to Electrical Ratings A,D,F,S only  
<sup>J</sup> Applies to Electrical Ratings D,F,S only  
<sup>K</sup> Applies to 150 g Operate Force and higher  
<sup>L</sup> Applies to 15 g to 150 g Operate Force  
<sup>M</sup> Applies to only 300 g Operate Force  
<sup>N</sup> Applies to only Electrical Rating V  
<sup>P</sup> Applies to only Electrical Ratings K,Z

Formed levers available

# MICRO SWITCH PREMIUM BASIC SWITCHES, V7 SERIES

O.F. • Operating force  
 R.F. • Release force  
 P.T. • Pretravel  
 O.T. • Overtravel  
 D.T. • Differential travel  
 O.P. • Operating position

## PRODUCT SPECIFICATIONS AND LISTINGS

Contact your Honeywell rep or distributor for additional listings





	Catalog Listing	Elect. Rating UL/CSA (CE)	Elect. Rating Spec. (page 2)	Contacts	O.F. max. newtons [grams]	O.P. nominal mm [inches]	P.T. max. mm [inches]	O.T. min. mm [inches]	D.T. mm [inches]
	<b>V7-2S17DB</b>	0.1 A (---)	S	SPDT	0,79 [75]	14,7 [0.578]	1,19 [0.047]	1,27 [0.050]	0,05 - 0,25 [0.002-0.010]
	<b>V7-1S17D8</b>	0.1 A (---)	S	SPDT	1,47 [150]	14,7 [0.578]	1,19 [0.047]	1,27 [0.050]	0,05 - 0,25 [0.002-0.010]
	<b>V7-5F17D8</b>	3 A (---)	F	SPDT	0,15 [15]	14,7 [0.578]	1,19 [0.047]	1,27 [0.050]	0,05 - 0,25 [0.002-0.010]
	<b>V7-4A17D8</b>	5 A (---)	A	SPDT	0,25 [25]	14,7 [0.578]	1,19 [0.047]	1,27 [0.050]	0,05 - 0,25 [0.002-0.010]
	<b>V7-3E17D8</b>	10 A (---)	E	SPDT	0,49 [50]	14,7 [0.578]	1,19 [0.047]	1,27 [0.050]	0,05 - 0,25 [0.002-0.010]
	<b>V7-1B37D8</b>	11 A (---)	B	SPNC	1,47 [150]	14,7 [0.578]	1,19 [0.047]	1,27 [0.050]	0,05 - 0,25 [0.002-0.010]
	<b>V7-2B17D8</b>	11 A (---)	B	SPDT	0,74 [75]	14,7 [0.578]	1,19 [0.047]	1,27 [0.050]	0,05 - 0,25 [0.002-0.010]
	<b>V7-2B17E9</b>	11 A (---)	B	SPDT	0,74 [75]	14,7 [0.578]	1,19 [0.047]	1,27 [0.050]	0,05 - 0,25 [0.002-0.010]
<b>Pin plunger</b>	<b>V7-7B17D8</b>	11 A (---)	B	SPDT	2,22 [227]	14,7 [0.578]	1,19 [0.047]	1,27 [0.050]	0,05 - 0,25 [0.002-0.010]
	<b>V7-1C17D8</b>	15 A (---)	C	SPDT	1,47 [150]	14,7 [0.578]	1,19 [0.047]	1,27 [0.050]	0,05 - 0,25 [0.002-0.010]
	<b>V7-1C17E9</b>	15 A (---)	C	SPDT	1,47 [150]	14,7 [0.578]	1,19 [0.047]	1,27 [0.050]	0,05 - 0,25 [0.002-0.010]
	<b>V7-1C37D8</b>	15 A (---)	C	SPNC	1,47 [150]	14,7 [0.578]	1,19 [0.047]	1,27 [0.050]	0,05 - 0,25 [0.002-0.010]
	<b>V7-1V19E9</b>	21 A (16 A)	V	SPDT	1,72 [175]	14,7 [0.578]	1,19 [0.047]	1,27 [0.050]	0,05 - 0,25 [0.002-0.010]
	<b>V7-1V29E9</b>	21 A (16 A)	V	SPNO	1,72 [175]	14,7 [0.578]	1,19 [0.047]	1,27 [0.050]	0,05 - 0,25 [0.002-0.010]
	<b>V7-1V39E9</b>	21 A (16 A)	V	SPNC	1,72 [175]	14,7 [0.578]	1,19 [0.047]	1,27 [0.050]	0,05 - 0,25 [0.002-0.010]
	<b>V7-1Z19E9</b>	25 A (20 A)	Z	SPDT	2,21 [225]	14,7 [0.578]	1,19 [0.047]	1,27 [0.050]	0,05 - 0,25 [0.002-0.010]
	<b>V7-1Z29E9</b>	25 A (20 A)	Z	SPNO	2,21 [225]	14,7 [0.578]	1,19 [0.047]	1,27 [0.050]	0,05 - 0,25 [0.002-0.010]
	<b>V7-1Z20E9*</b>	25 A (20 A)	Z	SPNO	2,21 [225]	14,7 [0.578]	1,19 [0.047]	1,27 [0.050]	0,05 - 0,25 [0.002-0.010]
<b>Lever 22,1 mm [0.87 in]</b>	<b>V7-1C17D8-002</b>	15 A (---)	C	SPDT	1,57 [160]	15,2 [0.600]	1,52 [0.060]	0,89 [0.035]	0,36 [0.015] max.
	<b>V7-1C17E9-002</b>	15 A (---)	C	SPDT	1,57 [160]	15,2 [0.600]	1,52 [0.060]	0,89 [0.035]	0,36 [0.015] max.
	<b>V7-6C18D8-002*</b>	15 A (---)	C	SPDT	4,05 [413]	15,2 [0.600]	1,52 [0.060]	0,89 [0.035]	0,36 [0.015] max.

# MICRO SWITCH PREMIUM BASIC SWITCHES, V7 SERIES

O.F. • Operating force  
 R.F. • Release force  
 P.T. • Pretravel  
 O.T. • Overtravel  
 D.T. • Differential travel  
 O.P. • Operating position

## PRODUCT SPECIFICATIONS AND LISTINGS

Contact your Honeywell rep or distributor for additional listings

	Catalog Listing	Elect. Rating UL/CSA (CE)	Elect. Rating Spec. (page 2)	Contacts	O.F. max. newtons [grams]	O.P. nominal mm [inches]	P.T. max. mm [inches]	O.T. min. mm [inches]	D.T. mm [inches]
<b>Lever 35,6 mm [1.40 in]</b> 	V7-1S17D8-022	0.1 A (---)	S	SPDT	0,83 [85]	15,2 [0.60]	3,04 [0.120]	2,16 [0.085]	0,76 [0.030] max.
	V7-3S17D8-022	0.1 A (---)	S	SPDT	0,29 [30]	15,2 [0.60]	3,04 [0.120]	2,16 [0.085]	0,76 [0.030] max.
	V7-3S17E9-022	0.1 A (---)	S	SPDT	0,29 [30]	15,2 [0.60]	3,04 [0.120]	2,16 [0.085]	0,76 [0.030] max.
	V7-1B17D8-022	11 A (---)	B	SPDT	0,80 [82]	15,3 [0.603]	3,04 [0.120]	1,70 [0.067]	0,69 [0.027] max.
	V7-1B19D8-022	11 A (10 A)	B	SPDT	0,80 [82]	15,3 [0.603]	3,25 [0.128]	1,78 [0.070]	0,71 [0.028] max.
	V7-2B17D8-022	11 A (---)	B	SPDT	0,40 [41]	15,3 [0.603]	3,04 [0.120]	1,70 [0.067]	0,71 [0.027] max.
	V7-6B19E9-022	11 A (10 A)	B	SPDT	2,11 [215]	15,2 [0.60]	3,25 [0.128]	1,35 [0.053]	0,76 [0.030] max.
<b>Lever 59,4 mm [2.34 in]</b> 	V7-3S17D8-048	0.1 A (---)	S	SPDT	0,16 [16]	15,3 [0.603]	5,97 [0.235]	3,00 [0.118]	1,27 [0.050] max.
	V7-2B17D8-048	11 A (---)	B	SPDT	0,20 [20]	15,3 [0.603]	5,97 [0.235]	2,92 [0.115]	1,27 [0.050] max.
	V7-1C17D8-048	15 A (---)	C	SPDT	0,44 [45]	15,2 [0.603]	5,94 [0.234]	4,19 [0.165]	1,52 [0.060] max.
	V7-1V19E9-048	21 A (16 A)	V	SPDT	0,54 [55]	15,4 [0.605]	6,35 [0.250]	3,05 [0.120]	1,40 [0.055] max.
	V7-9W1AE9-048**	15 A (---)	W	SPDT	0,88 [90]	15,2 [0.603]	6,35 [0.250]	3,15 [0.124]	1,37 [0.054] max.
<b>Lever Sim. Roll 32,8 mm [1.29 in]</b> 	V7-1S17D8-263	0.1 A (---)	S	SPDT	0,88 [90]	18,54 [0.730]	2,79 [0.110]	1,90 [0.075]	0,76 [0.030] max.
	V7-3E19E9-263	10 A (5 A)	E	SPDT	0,32 [33]	18,54 [0.730]	2,54 [0.100]	1,90 [0.075]	0,76 [0.030] max.
	V7-1B17D8-263	11 A (---)	B	SPDT	0,88 [90]	18,54 [0.730]	2,79 [0.110]	1,52 [0.060]	0,76 [0.030] max.
	V7-1C17D8-263	15 A (---)	C	SPDT	0,89 [91]	18,54 [0.730]	2,79 [0.110]	1,55 [0.061]	0,61 [0.024] max.
	V7-1V29E9-263	21 A (16 A)	V	SPNO	1,08 [110]	18,49 [0.728]	2,90 [0.114]	1,62 [0.064]	0,64 [0.025] max.
	V7-1Z10E9-263*	25 A (20 A)	Z	SPDT	1,33 [136]	18,49 [0.728]	2,90 [0.114]	1,62 [0.064]	0,64 [0.025] max.
<b>Lever, Roller 20,57 mm [0.81 in]</b> 	V7-2S17D8-201	0.1 A (---)	S	SPDT	0,88 [90]	20,57 [0.810]	1,19 [0.047]	1,02 [0.040]	0,38 [0.015] max.
	V7-6B19E9-201	11 A (10 A)	B	SPDT	4,50 [459]	20,52 [0.808]	1,42 [0.056]	0,86 [0.034]	0,33 [0.013] max.
	V7-7B17D8-201	11 A (---)	B	SPDT	2,78 [283]	20,52 [0.808]	1,42 [0.056]	0,86 [0.034]	0,33 [0.013] max.
	V7-1C17D8-201	15 A (---)	C	SPDT	1,72 [175]	20,57 [0.810]	1,19 [0.047]	0,81 [0.032]	0,30 [0.012] max.
<b>Lever, Roller 34,04 mm [1.34 in]</b> 	V7-1S17D8-207	0.1 A (---)	S	SPDT	0,83 [85]	20,57 [0.810]	2,84 [0.112]	2,03 [0.080]	0,76 [0.030] max.
	V7-2A17D8-207	5 A (---)	A	SPDT	0,42 [43]	20,57 [0.810]	2,92 [0.115]	1,52 [0.060]	0,64 [0.025] max.
	V7-1B17D8-207	11 A (---)	B	SPDT	0,83 [85]	20,57 [0.810]	2,92 [0.115]	1,52 [0.060]	0,76 [0.030] max.
	V7-1C17D8-207	15 A (---)	C	SPDT	0,88 [90]	20,57 [0.810]	2,92 [0.115]	1,52 [0.060]	0,64 [0.025] max.
	V7-1V19E9-207	21 A (16 A)	V	SPDT	0,98 [100]	20,52 [0.808]	3,07 [0.121]	1,65 [0.065]	0,76 [0.030] max.

\*3,1 mm mtg holes

\*\* 177 °C [350 °F]

# MICRO SWITCH PREMIUM BASIC SWITCHES, V7 SERIES

## AVAILABLE TERMINALS

### Quick Connect (QC)

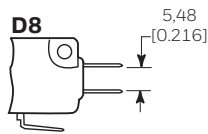

**D8 Terminals:** 0.187 in wide x 0.020 in thick.

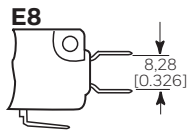

**E8 Terminals:** 0.187 in wide x 0.020 in thick.

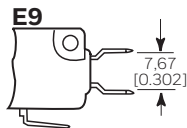

**E9 Terminals:** 0.250 in wide x 0.032 in thick.

### Printed Circuit Board (PO2)

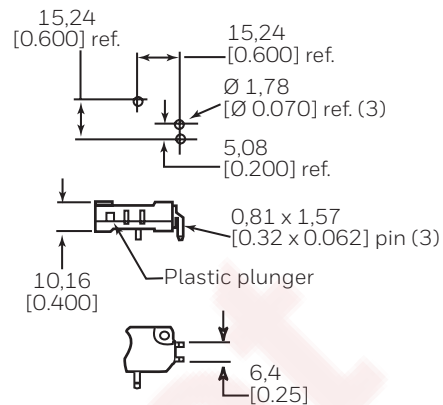

These terminals interface with snap-on receptacles and other components from AMPMODU interconnection system.

## STANDARD ACTUATOR OPTIONS

### Straight Lever (-002)

### Roller Lever (-201)

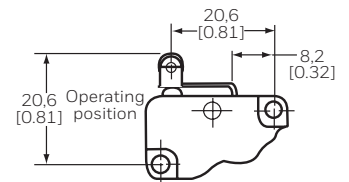
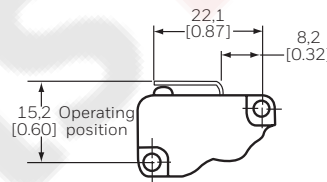
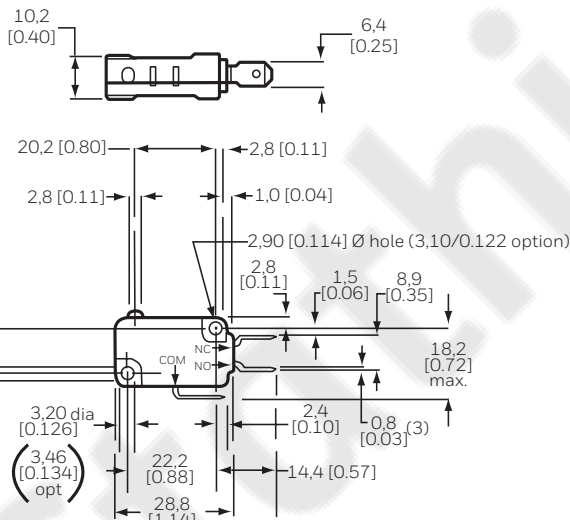

### Straight Lever (-022)

### Roller Lever (-207)

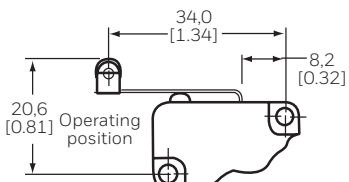
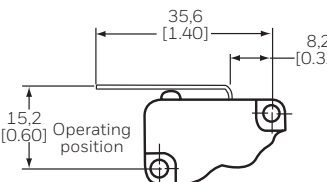

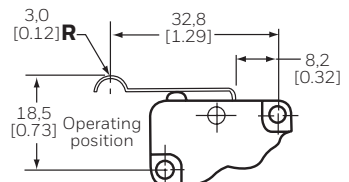
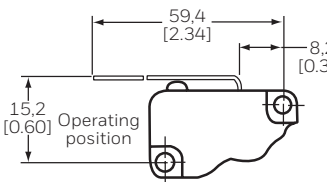

### Straight Lever (-048)

### Simulated Roller Lever (-263)



## ACCESSORIES

	Part Number	Description
	15PA177-V7	Insulator packet: 500 pieces of 0,46 mm [0.018 in] thick varnished fiberglass
	15PA260	Elastomer plunger boot seal: dust and splash resistant (Switch not included)

## WARRANTY/REMEDY

Honeywell warrants goods of its manufacture as being free of defective materials and faulty workmanship during the applicable warranty period. Honeywell's standard product warranty applies unless agreed to otherwise by Honeywell in writing; please refer to your order acknowledgment or consult your local sales office for specific warranty details. If warranted goods are returned to Honeywell during the period of coverage, Honeywell will repair or replace, at its option, without charge those items that Honeywell, in its sole discretion, finds defective.

**The foregoing is buyer's sole remedy and is in lieu of all other warranties, expressed or implied, including those of merchantability and fitness for a particular purpose. In no event shall Honeywell be liable for consequential, special, or indirect damages.**

While Honeywell may provide application assistance personally, through our literature and the Honeywell web site, it is buyer's sole responsibility to determine the suitability of the product in the application.

Specifications may change without notice. The information we supply is believed to be accurate and reliable as of this writing. However, Honeywell assumes no responsibility for its use.

## FOR MORE INFORMATION

Honeywell Sensing and Internet of Things services its customers through a worldwide network of sales offices and distributors. For application assistance, current specifications, pricing or the nearest Authorized Distributor, visit [sensing.honeywell.com](http://sensing.honeywell.com) or call:

International +815 618 3231  
USA/Canada +302 613 44915

### Honeywell Sensing and Internet of Things

9680 Old Bailes Road  
Fort Mill, SC 29707  
[honeywell.com](http://honeywell.com)

## ⚠ WARNING PERSONAL INJURY

DO NOT USE these products as safety or emergency stop devices or in any other application where failure of the product could result in personal injury.

**Failure to comply with these instructions could result in death or serious injury.**

## ⚠ WARNING MISUSE OF DOCUMENTATION

- The information presented in this product sheet is for reference only. Do not use this document as a product installation guide.
- Complete installation, operation, and maintenance information is provided in the instructions supplied with each product.

**Failure to comply with these instructions could result in death or serious injury.**

# Mouser Electronics

Authorized Distributor

Click to View Pricing, Inventory, Delivery & Lifecycle Information:

## Honeywell:

[V7-1A17D8](#) [V7-1A17D8-048](#) [V7-1A17D8-057](#) [V7-1A27D8-207](#) [V7-1A27D8-636](#) [V7-1B10E9-207](#) [V7-1B17D8](#) [V7-1B17D8-022](#) [V7-1B17D8-048](#) [V7-1B17D8-048-S](#) [V7-1B17D8-122](#) [V7-1B17D8-263](#) [V7-1B19D8-022](#) [V7-1B19E9](#) [V7-1B27D8-048](#) [V7-1B29P07-022](#) [V7-1B37D8](#) [V7-1B37D8-263](#) [V7-1C17D8](#) [V7-1C17D8-002](#) [V7-1C17D8-022](#) [V7-1C17D8-048](#) [V7-1C17D8-201](#) [V7-1C17D8-207](#) [V7-1C17D8-263](#) [V7-1C17E9](#) [V7-1C17E9-002](#) [V7-1C17E9-201](#) [V7-1C17E9-207](#) [V7-1C17E9-292](#) [V7-1C18E9](#) [V7-1C18E9-022](#) [V7-1C27D855-002](#) [V7-1C27E9](#) [V7-1C27E9-263](#) [V7-1C27E9-292](#) [V7-1C28E9](#) [V7-1C37D8](#) [V7-1C37D855-002](#) [V7-1C39E9](#) [V7-1D10D8](#) [V7-1E10D8](#) [V7-1K20E9](#) [V7-1K29E9](#) [V7-1S17D8](#) [V7-1S17D8-022](#) [V7-1S17D8-201](#) [V7-1S17D8-207](#) [V7-1S17D8-263](#) [V7-1S19D8-369](#) [V7-1V19E9](#) [V7-1V19E9-048](#) [V7-1V19E9-207](#) [V7-1V19E9-269](#) [V7-1V20E94](#) [V7-1V29E9](#) [V7-1V29E9-263](#) [V7-1V39E9](#) [V7-1X1AD9C1](#) [V7-1X2AD8-048](#) [V7-1X2AE9-048](#) [V7-1Z10E9](#) [V7-1Z19E9](#) [V7-1Z20E9](#) [V7-1Z29D94](#) [V7-1Z29E9](#) [V7-1Z39E9](#) [V7-2A17D8-022](#) [V7-2A17D8-207](#) [V7-2A17E9](#) [V7-2A27D8](#) [V7-2A27E9](#) [V7-2B17D8](#) [V7-2B17D8-022](#) [V7-2B17D8-048](#) [V7-2B17D8-162](#) [V7-2B17D8-201](#) [V7-2B17D8-207](#) [V7-2B17E9](#) [V7-2B17P02](#) [V7-2B19E9-048](#) [V7-2B27D8-022](#) [V7-2B27P07](#) [V7-2B29D8](#) [V7-2B29E9](#) [V7-2B29E9-048](#) [V7-2E17E9-366](#) [V7-2E17E9-420](#) [V7-2S17D8](#) [V7-2S17D8-022](#) [V7-2S17D8-201](#) [V7-2S17E9-420](#) [V7-3A17D8](#) [V7-3E17D8](#) [V7-3E17E9](#) [V7-3E17E9-022](#) [V7-3E19E9](#) [V7-3E27E9](#) [V7-3E29E9](#) [V7-3S17D8-000-3](#)