

- 1、FUNCTION: OFF-ON
- 2、RATING: UL: TV-5
ENEC VDE/CQC: 8A/128A μ 250V~T85
- 3、OPERATION FORCE: 700 \pm 300g.f
- 4、CONTACT RESISTANCE: \leq 50 m Ω
- 5、INSULATION RESISTANCE: \geq 100 M Ω
- 6、DIELECTRIC WITHSTAND: TERMINAL TO BUTTON 3000VAC/5mA/1MINTUE
TERMINAL TO TERMINAL 1500VAC/5mA/1MINTUE

7、TRAVEL:

FULL TRAVEL	4.0 \pm 0.5mm
LOCK TRAVEL	2.5 \pm 0.5mm

8、CIRCUIT DIAGRAM:

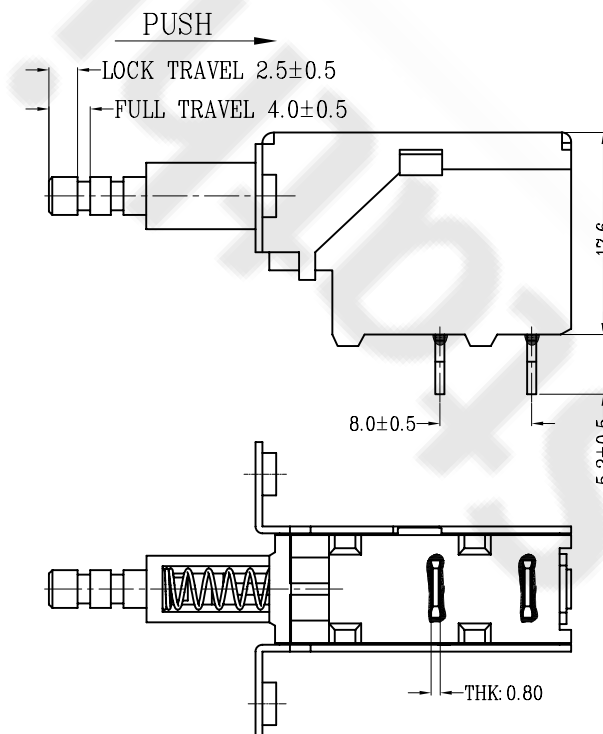
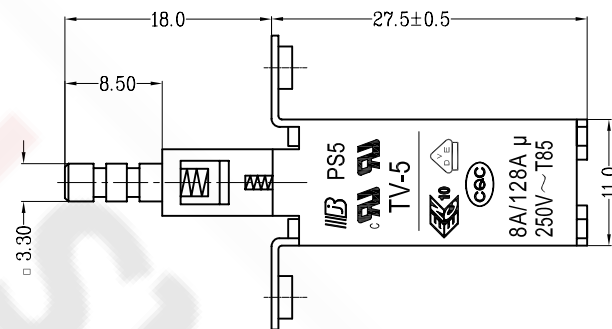
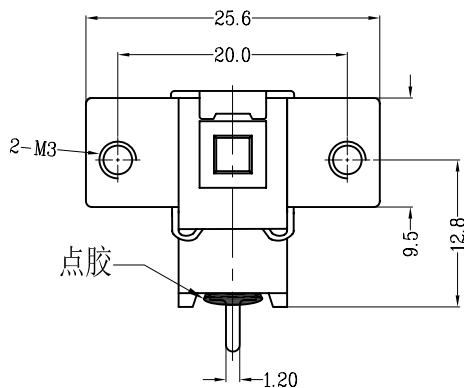
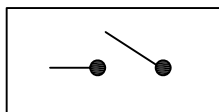

TOLERANCE UNLESS SPECIFIED					
.X: \pm 0.30 .XX \pm 0.1 ANGULAR: 3.0°					
PROJECTION		V1.0			
ISSUE	DATE	DESCRIPTIONS OF REVISION			APPD.
TITLE: PUSH SWITCH		UNIT: mm	SCALE: NOT SCALE	DRWG NO: BEJ-FH-W0882	
MODEL: PS5A-02-Y1-01		FUNCTION OFF-ON		DWN.	吴为萍 2017-11-23
				CHK'D.	冯辉 2017-11-23
				APPD.	谭云锋 2017-11-23
贝尔佳电子有限公司 BEI ER JIA ELECTRONICS CO.,LTD					



Product Specification (產品規格書)

Model No.(型號):
PS5 SeriesIssue Date(發佈日期):
2015 年 12 月 15 日**1. General** [一般描述]

- 1.1 Part name [產品名稱]: PS5 Series Push Switch [PS5 系列推推式电源開關]
- 1.2 Function[功能]: OFF -ON
OFF -(ON)
- 1.3 Operating temperature: -10°C~85°C
[使用環境溫度]
- 1.4 Standard testing condition: Normal Temperature(25°C±10°C)、Normal humidity(45~85%RH)、
[測試條件] Normal atmospheric pressure(860~1060hpa)
[溫度(25°C±10°C)、濕度(45~85%RH)、大氣壓力(860~1060hpa)]
- 1.5 Appearance [外觀]: See attached dwg. [見附件圖紙]

2. Approval/Rating [認證/規格]

Approval [安規]	Rating [規格]	Electrical Life [壽命]	Remarks [備註]
UL	TV-5	25K	Approved
ENEC VDE	8A/128A μ 250V~ T85	1E4	
CQC	8A/128A μ 250V~T85	1E4	

3. Electrical Characteristics [電氣特性]

No. [序號]	Item [項目]	Condition [條件]	Criteria [標準]
3.1	Electrical life [電氣壽命]	10,000 life cycles 25,000 life cycles [10,000 周次] [25,000 周次]	Switch perform 10 cycles of normal function after max. electrical life [開關達到最大電氣壽命後能繼續運行 10 周次]
3.2	Contact Resistance [接觸阻抗]	Initial : Test current:100mA [起始: 測試電流: 100mA]	$\leq 50m\Omega$
3.3	Contact gap [接觸間隙]	In off position [在 OFF 位]	$> 1.5mm$
3.4	Insulation resistance [絕緣阻抗]	Between terminals to case at 500 VDC for 5 seconds [腳與外殼間承受 500VDC, 保持 5 秒]	$\geq 100M\Omega$
3.5	Dielectric strength [耐壓強度]	Between terminals of contacts 1500VAC 5mA for 1 minute [腳與腳間承受 1500VAC, 5mA 保持 1 分鐘] Between terminals to button 3000VAC 5mA for 1 minute [腳與外殼間承受 3000VAC, 5mA 保持 1 分鐘]	Measurement before life test, no flash or dielectric breakdown [量度於壽命測試前, 無閃光或擊穿現象]



Product Specification (產品規格書)

Model No.(型號):
PS5 SeriesIssue Date(發佈日期):
2015 年 12 月 15 日

4. Load Test [负载测试]

No.[序號]	Item [項目]	Condition [條件]	Criteria [標準]
4.1 IEC61058 测试 [IEC61058 Test]	Increase-voltage at accelerated speed: [升壓加速測試]	Testing voltage & current: Increase 1.15 times The number of operating cycles: 100 Power factor: 0.6+0.05/-0 Ambient temperature: 25±10°C Operating rate&speed: 1s ON, 3s OFF; 80mm/s [測試電壓和電流: 1.15 倍額定電壓; 操作迴圈次數: 100 次; 功率因數: 0.6+0.05/-0; 環境溫度: 25±10°C; 操作頻率和速度: 1 秒通, 3 秒斷; 80mm/s;	1、 The temperature rise test at the terminal carried out under rated current and ambient temperature of 25±10°C the temperature rise at the terminal dose not exceed 55K. 2、 Between terminals of terminals, Between terminals to button 1500VAC 5mA for 1 minute, Contact Resistance≤ 100mΩ 3、 The on-off function is Ok, no electrical problem, no mechanical breakdown, no abnormal appearance. 1、 通額定電流, 在周圍溫度為 25±10°C 的條件下進行溫升測試, 端子溫升不應超過 55K。 2、 介電強度在端子之間, 端子與外殼之間, 通過 1500VAC/min 高壓試驗; 漏電流設為 5mA ; 接觸電阻≤100 mΩ 3、 通斷功能應正常, 無電氣或機械障, 外觀無異常。
	Slow speed test: [慢速測試]	Testing voltage & current: rated voltage & current The number of operating cycles: 100 Power factor: 0.6+0.05/-0 Ambient temperature: 25±10°C Operating rate&speed: 1s ON, 3s OFF; 20mm/s [測試電壓和電流: 額定電壓; 操作迴圈次數: 100 次; 功率因數: 0.6+0.05/-0; 環境溫度: 25±10°C ; 操作頻率和速度: 1 秒通, 3 秒斷; 20mm/s ;	
	Accelerated speed test: [加速測試]	Testing voltage & current: rated voltage & current The number of operating cycles: 9800 Power factor: 0.6+0.05/-0 Ambient temperature: 25±10°C Operating rate&speed: 1s ON, 3s OFF; 80mm/s [測試電壓和電流: 額定電壓; 操作迴圈次數: 9800 次; 功率因數: 0.6+0.05/-0; 環境溫度: 25±10°C ; 操作頻率和速度: 1 秒通, 3 秒斷; 80mm/s ;	
4.2 UL1054 测试 [UL1054 Test]	Overload Test: [过载測試]	Increase-current: Increase 150% The number of operating cycles: 50 Power factor: 1.0 Ambient temperature: 25±10°C Operating rate&speed: 6~10 cycles/min [測試電壓和電流: 150%倍額定電流; 操作迴圈次數: 50 次; 功率因數: 1.0; 環境溫度: 25±10°C ; 操作頻率和速度: 6~10 次/分钟 ;	1、 Between terminals of terminals, Between terminals to button 1000VAC 5mA for 1 minute, Contact Resistance≤ 100mΩ 2、 The on-off function is Ok, no electrical problem, no mechanical breakdown, no abnormal appearance. 1、 介電強度在端子之間, 端子與外殼之間, 通過 1000VAC/min 高壓試驗; 漏電流設為 5mA ; 接觸電阻≤100 mΩ 2、 通斷功能應正常, 無電氣或機械障, 外觀無異常。



Product Specification (產品規格書)

Model No.(型號):
PS5 SeriesIssue Date(發佈日期):
2015 年 12 月 15 日

4. Load Test [负载测试]

4.2
UL1054 测试
[UL1054 Test]Endurance test:
[耐久性测试]

Testing voltage & current: rated voltage & current
The number of operating cycles: 10000
Power factor: 1.0
Ambient temperature: 25±10°C
Operating rate&speed: 6~10 cycles/min
[测试电压和电流: 额定电压和电流; 操作迴圈次數: 10000 次; 功率因數: 1.0; 環境溫度: 25±10°C ; 操作頻率和速度: 6~10 次/分钟 ;

- 1、 The temperature rise test at the terminal carried out under rated current and ambient temperature of 25±10°C the temperature rise at the terminal dose not exceed 30°C.
 - 2、 Between terminals of terminals, Between terminals to button 1000VAC 5mA for 1 minute, Contact Resistance≤ 100mΩ
 - 3、 The on-off function is Ok, no electrical problem, no mechanical breakdown, no abnormal appearance.
- 1、 通額定電流，在周圍溫度為 25±10°C 的條件下進行溫升測試，端子溫升不應超過 30°C。
- 2、 介電強度在端子之間，端子與外殼之間，通過 1000VAC/min 高壓試驗；漏電流設為 5mA ；接觸電阻≤100 mΩ
- 3、 通斷功能應正常，無電氣或機械障，外觀無異常。

Continued endurance test:
[連續性耐久測試]

Testing voltage & current: rated voltage & current
The number of operating cycles: 15000
Power factor: 1.0
Ambient temperature: 25±10°C
Operating rate&speed: 6~10 cycles/min
[测试电压和电流: 额定电压和电流; 操作迴圈次數: 15000 次; 功率因數: 1.0; 環境溫度: 25±10°C ; 操作頻率和速度: 6~10 次/分钟 ;

- 1、 Between terminals of terminals, Between terminals to button 1000VAC 5mA for 1 minute.
 - 2、 The on-off function is Ok, no electrical problem, no mechanical breakdown, no abnormal appearance.
- 1、 介電強度在端子之間，端子與外殼之間，通過 1000VAC/min 高壓試驗；漏電流設為 5mA ；
- 2、 通斷功能應正常，無電氣或機械障，外觀無異常。

No.[序號]

Item [項目]

Condition [條件]

Criteria [標準]

4.1

Mechanical life
[機械壽命]Perform 100,000 cycles operations
[100,000 周次]No detachable parts & switch w/
normal function
[開關無損壞/功能正常]



Product Specification (產品規格書)

Model No.(型號):
PS5 SeriesIssue Date(發佈日期):
2015 年 12 月 15 日

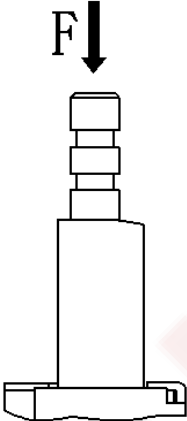
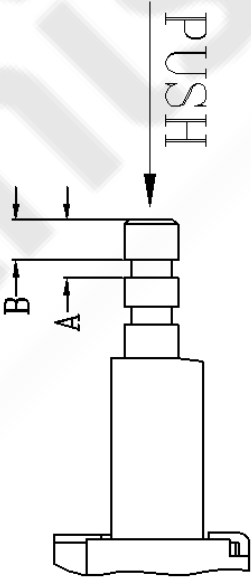
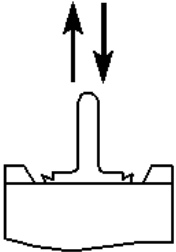
4.2	Operating force [操作力]	Vertical force apply to the highest point of button [垂直力壓于按鈕最高點，直至開關轉檔] 	700g•f±300g•f
4.3	Travel [行程]		A=Full Travel 4.0±0.5mm [A:全行程] B= Lock Travel 2.5±0.5mm [B:鎖住行程]
4.5	Terminal strength [端子強度]	Pulling & pushing force of max. 5kg apply to the terminal vertically [五金腳最大能承受垂直拔出/推入力5kg•f] 	No detach of terminal [腳無推入及脫離現象]



Product Specification (產品規格書)

Model No.(型號):
PS5 SeriesIssue Date(發佈日期):
2015 年 12 月 15 日

4.6	Solderability of terminals [端子可焊性]	Soldering temperature: $230 \pm 5^{\circ}\text{C}$ [焊接溫度 $230 \pm 5^{\circ}\text{C}$] Soldering time: 3 ± 0.5 seconds [焊接時間 3 ± 0.5 秒]	Solder should cover minimum 50% of soldering surface [焊接最少覆蓋 50% 焊接表面]
4.7	Resistance to soldering heat [焊接阻熱性]	Soldering temperature: $260 \pm 5^{\circ}\text{C}$ [焊接溫度 $260 \pm 5^{\circ}\text{C}$] Soldering time: 5 ± 0.5 seconds [焊接時間 5 ± 0.5 秒]	No damage of plastic [塑膠無損壞]
4.8	Flammability rating [防火等級]	Thermoplastic UL 94V-0 [熱固性塑膠 UL 94V-0]	\

5. Remarks: [備註]

Prepared by (制定):

吳為萍

Checked by (審核):

馮輝

Approved by (核准):

譚雲鋒

Date (日期): 2015-12-15

Date (日期): 2015-12-15

Date (日期): 2015-12-15