

Product Image

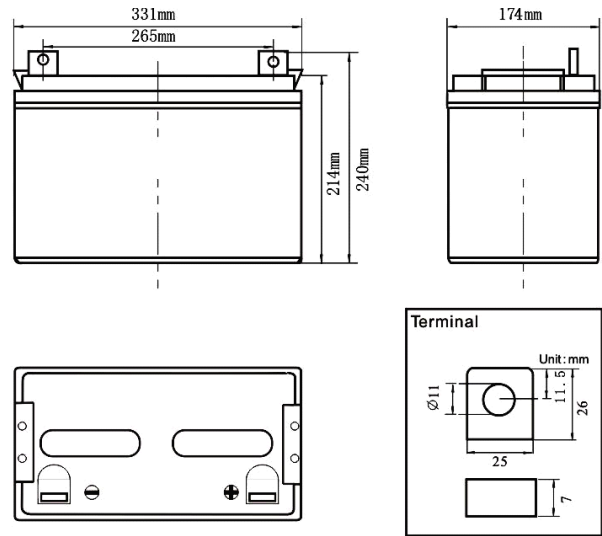

Product Dimensions



Characteristics

Nominal Voltage		12V
Nominal Capacity (10 hour rate)		100Ah
Capacity 25°C(77°F)	20 hour rate (5.55A)	111.0Ah
	5 hour rate (18.3A)	91.5Ah
	1 hour rate (66.5A)	66.5Ah
Internal Resistance	Full Charged Battery 25°C	≤5.0mΩ
Capacity affected by Temperature (10 hour)	40°C (104°F)	102%
	25°C (77°F)	100%
	0°C (32°F)	85%
	-15°C (5°F)	65%
Self-Discharge 25°C(77°F) Capacity	after 3 month storage	90%
	after 6 month storage	80%
	after 12 month storage	62%
Charge (Constant Voltage) 25°C (77°F)	Float	Initial Charging Current Less than 25.0A Voltage 13.6-13.8V
	Cycle	Initial Charging Current Less than 25.0A Voltage 14.4-14.9V

Packaging

Battery Dimensions	Length	331mm
	Width	174mm
	Height	214mm
	Total Height	240mm
Box Dimensions	Length	346mm
	Width	188mm
	Height	289mm
Quantity Per Box		1 PC per box
Net weight Per Cell		29.0kg±3%
Net weight Per Box		29.0kg
Gross Weight		29.5kg

Discharge Constant Current per Cell (Amperes at 77°F25°C)

F.V/Time	5min	10min	15min	30min	45min	1h	2h	3h	5h	8h	10h	20h
1.60V	336.3	224.0	168.8	105.1	75.4	66.5	40.5	29.6	19.1	11.6	10.40	5.77
1.65V	310.0	206.5	161.8	102.2	73.4	64.7	39.8	29.1	18.8	11.5	10.30	5.72
1.70V	315.2	210.0	154.8	99.4	71.3	63.0	39.1	28.6	18.5	11.4	10.20	5.66
1.75V	278.5	185.5	147.7	96.6	69.3	61.2	38.1	27.9	18.3	11.3	10.10	5.61
1.80V	262.7	175.0	140.7	93.8	67.3	59.4	37.2	27.2	18.0	11.2	10.00	5.55

Discharge Constant Power per Cell (Watts at 77°F 25°C)

F.V/Time	5min	10min	15min	30min	45min	1h	2h	3h	5h	8h	10h	20h
1.60V	627.1	417.8	314.9	195.9	140.6	124.1	75.6	55.3	35.6	21.7	19.4	10.8
1.65V	578.1	385.1	301.8	190.7	136.8	120.8	74.2	54.3	35.1	21.5	19.2	10.7
1.70V	587.9	391.7	288.6	185.4	133.0	117.4	72.8	53.3	34.6	21.3	19.0	10.6
1.75V	519.3	346.0	275.5	180.2	129.3	114.1	71.1	52.0	34.1	21.1	18.8	10.5
1.80V	489.9	326.4	262.4	174.9	125.5	110.8	69.4	50.7	33.6	20.9	18.7	10.4

Note The above data are average values, and can be obtained within 3 charge/discharge cycles. These are not minimum values. Cell and battery designs/specifications are subject to modification without notice.

Performance Characteristics

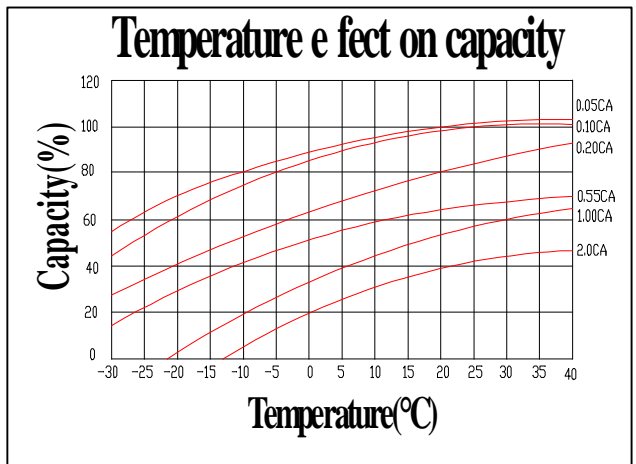
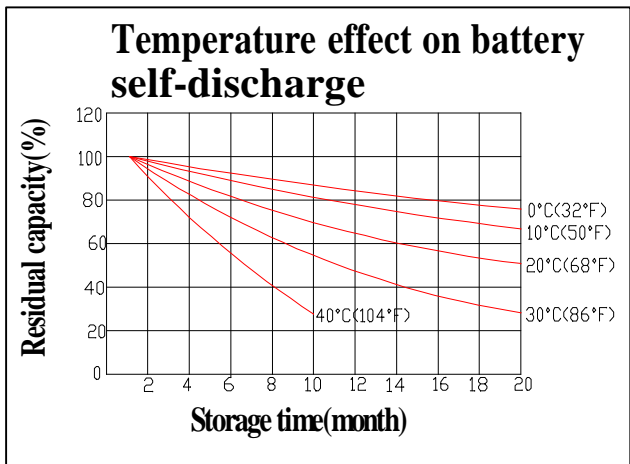
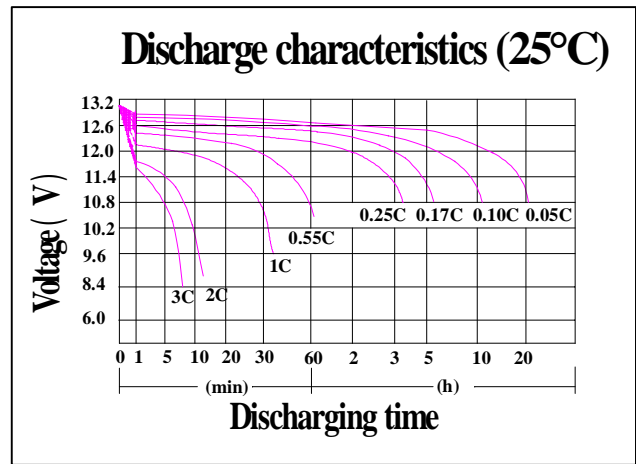
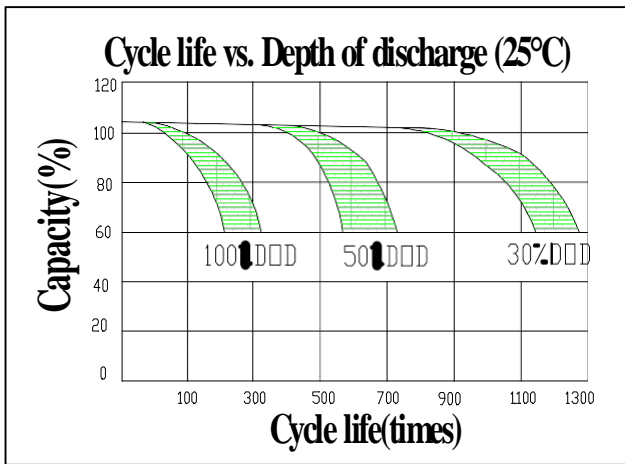
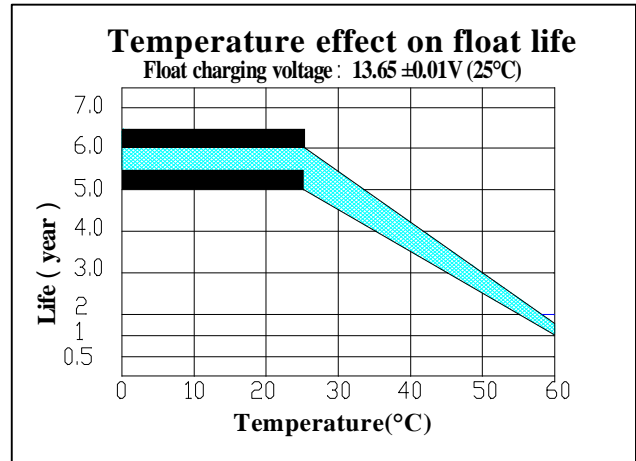
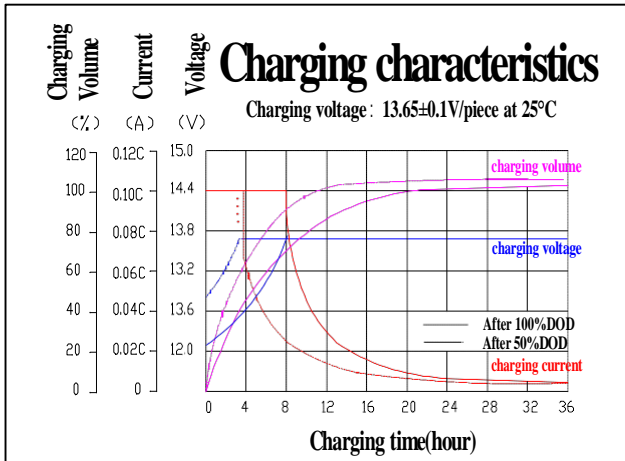

Battery Construction

Component	Positive plate	Negative plate	Container	Cover	Safety valve	Terminal	Separator	Electrolyte
Raw material	Lead dioxide	Lead	ABS	ABS	Si-Rubber	Lead	Fiberglass	Sulfuric acid