

UNI-T®



Certificate No. QAC0956661

UT602/603

Operating Manual

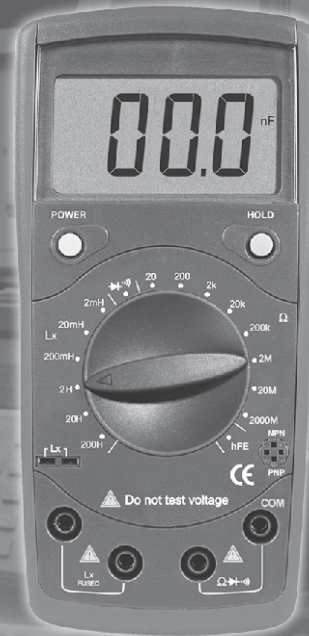

**Modern Inductance
Capacitance Meters**



P/N:110401103687

Table of Contents

Title	Page
Overview -----	3
Unpacking Inspection -----	4
Safety Information -----	4
Rules For Safe Operation -----	5
International Electrical Symbols -----	7
The Meter Structure -----	8
Functional Buttons -----	9
Display Symbols -----	10
Measurement Operation -----	11
A. Measuring Resistance -----	11
B. Diode and Continuity Test -----	13
C. Capacitance Measurement -----	15
D. Inductance Measurement -----	17
E. Transistor hFE Measurement -----	18
General Specifications -----	19
Accuracy Specifications -----	20
A. Resistance Test -----	20
B. Continuity & Diodes -----	21
C. Capacitance Test -----	21
D. Inductance Test -----	22
E. Transistor -----	22
Maintenance -----	23
A. General Service -----	23
B. Replacing the Battery -----	24
C. Replacing the Fuse -----	25

UNI-T®

Model UT602/603: OPERATING MANUAL

Overview

This Operating Manual covers information on safety and cautions. Please read the relevant information carefully and observe all the **Warnings** and **Notes** strictly.

Warning

To avoid electric shock or personal injury, read the "Safety Information" and "Rules for Safety Operation" carefully before using the Meter.

Digital Inductance Capacitance Meter **Model UT602/UT603** (hereafter referred to as "the Meter") is a 3 1/2 digits with steady operations, fashionable design and highly reliable hand-held measuring instrument.

The UT602 can measure inductance, while UT603 can measure capacitance and inductance. They both can measure resistance, transistor, diode and continuity buzzer

UT602 has an extra Data Hold feature.

Unpacking Inspection

Open the package case and take out the Meter. Check the following items carefully to see any missing or damaged part:

Item	Description	Qty
1	English Operating Manual	1 piece
2	Test Clip	1 pair
3	9V Alkaline Battery (NEDA1604, 6F22 or 006P) (installed)	1 piece

In the event you find any missing or damage, please contact your dealer immediately.

Safety Information

This Meter complies with the standards EMC EN61326. Use the Meter only as specified in this operating manual, otherwise the protection provided by the Meter may be impaired.

In this manual, a **Warning** identifies conditions and actions that pose hazards to the user, or may damage the Meter or the equipment under test.

A **Note** identifies the information that user should pay attention on.

International electrical symbols used on the Meter and in this Operating Manual are explained on page 7.

Rules For Safe Operation









Warning

To avoid possible electric shock or personal injury, and to avoid possible damage to the Meter or to the equipment under test, adhere to the following rules:

- 1 Before using the Meter inspect the case. Do not use the Meter if it is damaged or the case (or part of the case) is removed. Look for cracks or missing plastic. Pay attention to the insulation around the connectors.
- 1 Inspect the test clips for damaged insulation or exposed metal. Check the test clips for continuity. Replace damaged test clips with identical model number or electrical specifications before using the Meter.
- 1 Do not apply voltage to the Meter.
- 1 The rotary switch should be placed in the right position and no any changeover of range shall be made during measurement is conducted to prevent damage of the Meter.
- 1 Do not apply more than 30Vrms between the terminals and the grounding to avoid electric shock and damage to the Meter.
- 1 Use the proper terminals, function, and range for your measurements.
- 1 Do not use or store the Meter in an environment of high temperature, humidity, explosive, inflammable and strong magnetic field. The performance of the Meter may deteriorate after dampened.
- 1 Disconnect circuit power and discharge all high-voltage capacitors before testing resistance, continuity, capacitance or diodes.
- 1 Replace the battery as soon as the battery indicator  appears. With a low battery, the Meter might produce false readings that can lead to electric shock and personal injury.

- 1 Remove test clips from the Meter and turn the Meter power off before opening the Meter case.
- 1 When servicing the Meter, use only the same model number or identical electrical specifications replacement parts.
- 1 The internal circuit of the Meter shall not be altered at will to avoid damage of the Meter and any accident.
- 1 Soft cloth and mild detergent should be used to clean the surface of the Meter when servicing. No abrasive and solvent should be used to prevent the surface of the Meter from corrosion, damage and accident.
- 1 Turn the Meter power off when it is not in use and take out the battery when not using for a long time.
- 1 Please constantly check the battery as it may leak when it has been using for some time, replace the battery as soon as leaking appears. A leaking battery will damage the Meter.

International Electrical Symbols

	Grounding
	Double Insulated
	Deficiency of Built-In Battery.
	Continuity Test.
	Diode.
	Capacitance Test
Lx	Inductance Test
	Fuse.
	Warning. Refer to the Operating Manual.
	Conforms to Standards of European Union.

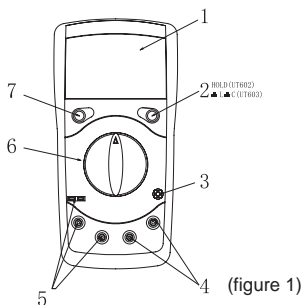
The Meter Structure (see figure 1)

1. LCD Display
2. Data Hold (UT602) or L-C switch (UT603)
3. Transistor Jack
4. Resistance, Diode and Continuity Input Terminal
5. Capacitance Input Terminal (UT602) or Capacitance and Inductance Input Terminal (UT603)
6. Rotary Switch
7. Power.



Functional Buttons

Below table indicated for information about the functional button operations.

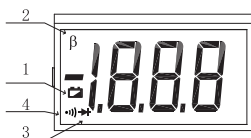

Button	Description
Power	Press the Power down to turn the Meter on.
	Press the Power again to turn the Meter power off.
Hold (UT602 only)	Press HOLD once to enter the hold feature, the LCD display H .
	Press HOLD again to exit hold feature, the H disappear.
L-C (UT603 only)	Press L-C down to enter the Capacitance measurement mode.
	Press L-C up to enter the Inductance measurement mode.

Display Symbols (see figure 2)

(figure 2)

No.	Symbol	Meaning
1		The battery is low. ⚠ Warning: To avoid false readings, which could lead to possible electric shock or personal injury, replace the battery as soon as the battery indicator appears.
2	β	Transistor Test
3		Test of diode.
4		The continuity buzzer is on.

Measurement Operation

- 1 Make sure the Low Battery Display  is not on, otherwise false readings may be provided.
- 1 Pay extra attention to the  symbol, before carrying measurement, which is located besides the input terminals of the Meter.

A. Measuring Resistance (see figure 3)

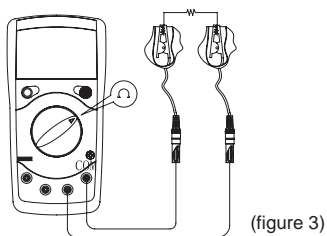

Warning

To avoid damages to the Meter or to the devices under test, disconnect circuit power and discharge all the high-voltage capacitors before measuring resistance.

The resistance ranges are 20Ω, 200Ω, 2kΩ, 20kΩ, 200kΩ, 2MΩ, 20MΩ and 2000MΩ.

To measure resistance, please connect the Meter as follows:

1. Insert the red test clip into the Ω  terminal and the black test clip into **COM** terminal.
2. Set the rotary switch to Ω range.
3. Connect the test clips across with the object being measured.

The measured value shows on the display.

Note

- 1 When measuring at 20Ω and 200Ω range, the test clips can add 0.1 to 0.3Ω error to resistance. To obtain precise readings in these low-resistance measurement, that is the range 20Ω and 200Ω , short circuit the input terminals beforehand and record the reading obtained (called this reading as X). (X) is the additional resistance from the test clips.

Then use the equation:

measured resistance value (Y) - (X) = precision readings of resistance.

- 1 The Meter displays "1" when there is no input, for example, open circuit situation.
- 1 For high resistance measurement ($>1M\Omega$), it is normal taking several seconds to obtain a stable reading.
- 1 When resistance measurement has been completed, disconnect the connection between the testing clips and the circuit under test and remove the testing clips away from the input terminals of the Meter.

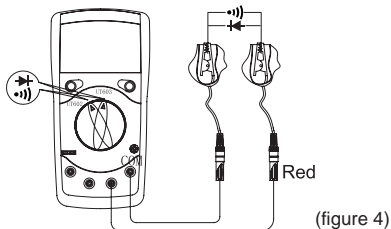
B. Diode and Continuity Test (see figure 4)**Warning**

To avoid damages to the Meter or to the devices under test, disconnect circuit power and discharge all the high-voltage capacitors before measuring diodes and continuity.

Do not input more than DC 60V or AC 30V voltages to avoid electric shock and damage to the Meter.

Testing Diodes

Use the diode test to check diodes, transistors, and other semiconductor devices. The diode test sends a current through the semiconductor junction, and then measures the voltage drop across the junction. A good silicon junction drops between 500mV and 800mV.

To test a diode out of a circuit, connect the Meter as follows:

1. Insert the red test clip into the $\Omega \rightarrow \text{diode symbol}$ terminal and the black test clip into the **COM** terminal.
2. Set the rotary switch to $\rightarrow \text{diode symbol}$.
3. For forward voltage drop readings on any semiconductor component, place the red test clip on the component's anode and place the black test clip on the component's cathode.

The display shows the diode forward voltage drop's nearest value.

Note

- 1 In a circuit, a good diode should still produce a forward voltage drop reading of 500mV to 800mV; however, the reverse voltage drop reading can vary depending on the resistance of other pathways between the probe tips.
- 1 Connect the test clips to the proper terminals as said above to avoid error display. The LCD will display "1" indicating open-circuit for wrong connection. The unit of diode is Volt (V), displaying the positive-connection voltage-drop value.
- 1 When diode test has been completed, disconnect the connection between the testing clips and the circuit under test and remove the testing clips away from the input terminals of the Meter.

Testing for Continuity

To test for continuity, connect the Meter as below:

1. Insert the red test clip into the Ω \rightarrow \bullet) terminal and the black test clip into the **COM** terminal.
2. Set the rotary switch to \rightarrow \bullet) .
3. Connect the test clips across with the object being measured.
4. The beeper comes on continuously when the resistance value of the tested circuit $\leq 10\Omega$. The beeper may or may not come on when the resistance value of the test circuit $> 10\Omega$
5. The Meter displays the value of the test resistance.

Note

- 1 The LCD displays "1" indicating the circuit being tested is open.
- 1 When continuity test has been completed, disconnect the connection between the testing clips and the circuit under test and remove the testing clips away from the input terminals of the Meter.

C. Capacitance Measurement (UT603 only, see figure 5)

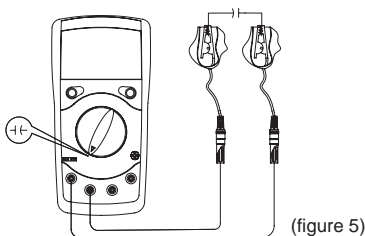

Warning

To avoid damage to the Meter or to the equipment under test, disconnect circuit power and discharge all high-voltage capacitors before measuring capacitance. Use the DC Voltage function to confirm that the capacitor is discharged.

The Meter's capacitance ranges are: 2nF, 20nF, 200nF, 2 μ F, 20 μ F, 200 μ F and 600 μ F.

To measure capacitance, connect the Meter as follows:

1. Set the rotary switch to **F** measurement mode. If the value of capacitor to be measured is unknown, use the maximum measurement position 600 μ F and decrease the range step by step until a satisfactory reading is obtained and the overloading icon "1" is disappeared.
2. Insert the red test clip into the **CAP +** terminal and black test clip into the **CAP -** terminal. For small value capacitor measurement, insert the capacitor into the small value jack.
3. Use the red test clip to clip the capacitor's positive and the black test clip to clip the capacitor's negative when the capacitor has polarity.
4. The measured value shows on the display.

Note

- 1 To minimize the effect of capacitance stored in the test clips, the test clips should be as short as possible and use the small value jack when measuring small value of capacitance.
- 1 The Meter cannot check the quality of the capacitor.
- 1 For large capacitor, please make sure the contact is stable and reliable.
- 1 When the tested capacitor is leaking or damaged and the tested value is not stable, the capacitor may have problems. You need to use other tools or equipment to check and confirm.

When capacitance measurement has been completed, disconnect the connection between the testing clips and the circuit under test and remove the testing clips away from the input terminals of the Meter.

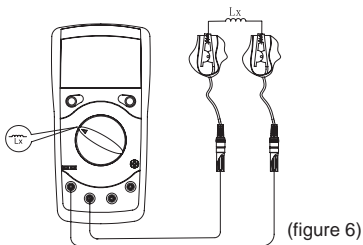
D. Inductance Measurement (see figure 6)

To test the inductance, please follow the following procedure:

1. Set the rotary switch to **Lx** measurement mode.
2. If the tested inductance value is unknown, use the maximum measurement position and decrease the range step by step until a satisfactory reading is obtained.
3. Insert the test clips into the corresponding **Lx** input terminals.
4. Use the test clips to clip the inductance to carry out the testing.
5. The measured value shows on the display.

Remarks:

- 1 When carrying out measurement at 2mH, short circuit the test clip first, then carrying out the measurement. The actual correct reading is the measured reading minus the short circuit reading.
- 1 When testing a small value inductance, it is better to use the small value jack.
- 1 The Meter cannot check the quality of the inductance.
- 1 When inductance measurement has been completed, disconnect the connection between the testing clips and the circuit under test and remove the testing clips away from the input terminals of the Meter.

E. Transistor hFE Measurement (see figure 7)

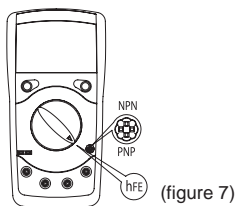



To measure transistor, set up the Meter as follows:

1. Set the rotary switch to **hFE** measurement mode.
2. Check that the transistor is PNP or NPN type.
3. Insert the transistor to be measured to the corresponding **Transistor Jack**
4. The Meter displays the tested transistor's nearest value

Note:

- 1 When transistor measurement has been completed, disconnect the connection between the testing clips and the circuit under test and remove the testing clips away from the input terminals of the Meter.

General Specifications

- l Fused Protection for Inductance Input Terminal (UT602):
0.315A, 250V, fast type fuse, ϕ 5x20 mm.
Fuse Protection for Inductance and capacitance Input Terminal (UT603):
0.315A, 250V, fast type fuse, ϕ 5x20 mm.
- l Maximum Display: Display: 1999.
- l Measurement Speed: Updates 2-3 times /second.
- l Polarity: Auto. (Display "-" when negative)
- l Overloading: Display "1"
- l Range: Manual Ranging
- l Temperature:
 - Operating: 0°C~40°C (32°F ~104°F).
 - Storage: -10°C~50°C (14°F~122°F).
- l Relative Humidity:
 - ≤75% @ 0°C - 30°C;
 - ≤50% @ 31 - 40°C.
- l Altitude:
 - Operating: 2000 m.
 - Storage: 10000 m.
- l Battery Type: One piece of 9V Alkaline (NEDA1604 or 0062 or 6F22 or 006P).
- l Battery Deficiency: Display 
- l Dimensions (HxWxL): 172 x 83 x 38 mm.
- l Weight: Approximate 310g (battery included).
- l Safety/Compliances: EMC EN61326.
- l Certification:  .

Accuracy Specifications

Accuracy: $\pm(a\% \text{ reading} + b \text{ digits})$, guarantee for 1 year.

Operating temperature: $23^{\circ}\text{C} \pm 5^{\circ}\text{C}$.

Relative humidity: $< 75\%$.

Temperature coefficient: $0.1 \times (\text{specified accuracy}) / 1^{\circ}\text{C}$

A. Resistance Test

Range	Resolution	Accuracy	
		UT602	UT603
20 Ω	0.01 Ω	$\pm(1\%+5)$	
200 Ω	0.1 Ω	$\pm(0.8\%+3)$	
2k Ω	1 Ω	$\pm(0.8\%+1)$	
20k Ω	10 Ω		
200k Ω	100 Ω		
2M Ω	1k Ω		
20M Ω	10k Ω	$\pm[2\%(\text{rdg}-12)+5]$	
2000M Ω	1M Ω	Reference only	

Remarks:

- I Overload protection: 250V DC or AC rms at all ranges.
- I At 20M Ω range, short circuit test lead, LCD displaying 12 digits is normal. During measurement minus these 12 digits from the obtained reading.
- I When measuring 20 Ω and 200 Ω range, short circuit test clips to display the resistance value of the test lead. Subtract this value from the measurement value to obtain the correct tested value.

B. Continuity & Diodes

Function	Range	Resolution	Overload Protection
Diode	→+	1mV	250V rms
Continuity	••))	1Ω	

Remarks:

I Diode:

Open Circuit Voltage around 5.8V, forward current around 1mA.

I Continuity

≤ 10Ω, beeper comes on continuously.

> 10Ω, beeper may or may not comes on.

C. Capacitance Test (UT603 only)

Range	Resolution	Accuracy	Testing Frequency / Voltage
2.000nF	0.001nF	±(1%+5)	1kHz/150mV
20.00nF	0.01nF		
200.0nF	0.1nF		
2.000μF	0.001μF	±(4%+5)	100Hz/15mV
20.00μF	0.01μF		
200.0μF	0.1μF		
600μF	0.001mF	Reference only	100Hz/1.5mV

Remarks:

I Overload Protection

0.315A, 250V, fast type fuse, φ5x20 mm

I Measure of Capacitance:

1F=10³mF = 10⁶μF= 10⁹nF = 10¹²pF

I Discharge all high-voltage capacitors before testing capacitance.

D. Inductance Test

Range	Resolution	Accuracy		Tested Frequency / Current
		UT602	UT603	
2mH	0.001mH	$\pm(2\%+8)$		1kHz/150 μ A
20mH	0.01mH			
200mH	0.1mH			
2H	0.001H	$\pm(5\%+5)$		100Hz/15 μ A
20H	0.01H	$\pm(5\%+15)$		
200H	0.1H	Reference only		

Remarks:

I Measure of Inductance: 1H=10³mH = 10⁶ μ H.

I Overload Protection:

0.315A, 250V, fast type fuse, ϕ 5x20 mm

E. Transistor

Range	Resolution	Testing Condition	Remarks
hFE	1 β	Vce \approx 5.8V I _{bo} \approx 10 μ A	The display value is the tested transistor's (NPN, PNP) nearest value (0~1000 β)

Maintenance

This section provides basic maintenance information including battery and fuse replacement instruction.



Warning

Do not attempt to repair or service your Meter unless you are qualified to do so and have the relevant calibration, performance test, and service information.

To avoid electrical shock or damage to the Meter, do not get water inside the case.

A. General Service

- I Periodically wipe the case with a damp cloth and mild detergent. Do not use abrasives or solvents.
- I To clean the terminals with cotton bar with detergent, as dirt or moisture in the terminals can affect readings.
- I Turn the Meter power off when it is not in use and take out the battery when not using for a long time.
- I Do not store the Meter in a place of humidity, high temperature and strong magnetic field.

B. Replacing the Battery (see figure 8)

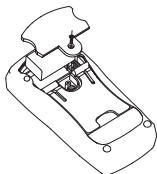

(figure 8)

Warning

To avoid false readings, which could lead to possible electric shock or personal injury, replace the battery as soon as the battery indicator "  " appears.

To replace the battery:

1. Turn the Meter power off and remove all connections from the terminals.
2. Remove the screw from the battery compartment, and separate the battery compartment from the case bottom.
3. Remove the battery from the battery compartment.
4. Replace the battery with a new 9V alkaline battery (NEDA1604 or 0062 or 6F22 or 006P)
5. Rejoin the case bottom and battery compartment, and reinstall the screw.

C. Replacing the Fuse (see figure 9)

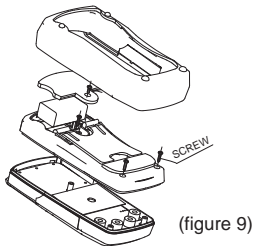

Warning

To avoid electrical shock or arc blast, or personal injury or damage to the Meter, use specified fuses ONLY in accordance with the following procedure.

To replace the Meter's fuse:

1. Turn the Meter power off and remove all connections from the terminals.
2. Remove the screw from the battery compartment, and separate the battery compartment from the case bottom.
3. Remove the screws from the case bottom, and separate the case top from the case bottom.
4. Remove the fuse by gently prying one end loose, then take out the fuse from its bracket.
5. Install ONLY replacement fuses with the identical type and specification as follows and make sure the fuse is fixed firmly in the bracket.
Fuse 1: 0.315A, 250V, fast type fuse, $\phi 5 \times 20$ mm.
6. Rejoin the battery compartment and the case top, and reinstall the screw.
7. Rejoin the case bottom and case top, and reinstall the screws.

Replacement of the fuses is seldom required. Burning of a fuse always results from improper operation.

**** END ****

This operating manual is subject to change without notice.

©Copyright 2005 Uni-Trend Group Limited.
All rights reserved.

Manufacturer:
Uni-Trend Technology (China) Limited
No 6, Gong Ye Bei 1st Road
Songshan Lake National High-Tech Industrial
Development Zone, Dongguan City
Guangdong Province
China
Postal Code: 523 808

Headquarters:
Uni-Trend Group Limited
Rm901, 9/F, Nanyang Plaza
57 Hung To Road
Kwun Tong
Kowloon, Hong Kong
Tel: (852) 2950 9168
Fax: (852) 2950 9303
Email: info@uni-trend.com
<http://www.uni-trend.com>