

# HFD41/D41A

# SUBMINIATURE SIGNAL RELAY



File No.: E133481



File No.: R50265409  
(Only HFD41A)



File No.: CQC15002123047 (Only HFD41A)

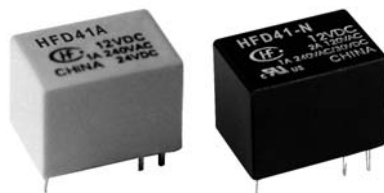

## Features

- 5A switching capability
- 1 Form C configuration
- Standard PCB layout
- Plastic sealed and flux proofed types available
- UL insulation system: Class F available
- Environmental friendly product (RoHS compliant)
- Outline Dimensions: (15.7 x 11.0 x 12.0) mm

## CONTACT DATA

Contact arrangement	1C
Contact resistance	100mΩ max. (at 1A 6VDC)
Contact material	AgNi, AgCdO
Contact rating (Res. load)	1A 120VAC, 1A 240VAC / 30VDC 3A 120VAC 2A 120VAC, 5A 120VAC
Max. switching voltage	240VAC / 30VDC
Max. switching current	5A
Max. switching power	600VA / 30W
Mechanical endurance	1 x 10 <sup>7</sup> OPS
Electrical endurance	9.9 x 10 <sup>4</sup> OPS (1A 120VAC, 1A 30VDC, Resistive load, Room temp., 1s on 9s off)

## CHARACTERISTICS

Insulation resistance	100MΩ (at 500VDC)	
Dielectric strength	Between coil & contacts	1000VAC 1min
	Between open contacts	500VAC 1min
Operate time (at nomi. volt.)	10ms max.	
Release time (at nomi. volt.)	5ms max.	
Shock resistance	Functional	98m/s <sup>2</sup>
	Destructive	980m/s <sup>2</sup>
Vibration resistance	10Hz to 55Hz 1.5mm DA	
Humidity	5% to 85% RH	
Ambient temperature	-25°C to 70°C	
Termination	PCB (DIP)	
Unit weight	Approx. 5g	
Construction	Plastic sealed, Flux proofed	

- Notes:** 1) The data shown above are initial values.  
2) Please find coil temperature curve in the characteristic curves below.  
3) UL insulation system: Class F, Class B.

## COIL

Coil power	B type: Approx. 450mW; N type: Approx. 360mW; H type: Approx. 200mW
------------	---

## COIL DATA

at 23°C

Nominal Voltage VDC	Pick-up Voltage VDC max.	Drop-out Voltage VDC min.	Max. Voltage VDC	Coil Resistance x (1±10%) Ω		
				H	N	B
3	2.3	0.3	3.9	45	25	20
5	3.8	0.5	6.5	120	70	56
6	4.5	0.6	7.8	180	100	80
9	6.8	0.9	11.7	400	220	180
12	9.0	1.2	15.6	700	400	320
24	18.0	2.4	31.2	2800	1600	1280

## SAFETY APPROVAL RATINGS

UL/CUL	1A 120VAC, 1A 240VAC/30VDC 2A 120VAC, 3A 120VAC 5A 120VAC
TÜV	1A 120VAC/30VDC

- Notes:** 1) All values unspecified are at room temperature.  
2) Only typical loads are listed above. Other load specifications can be available upon request.



HONGFA RELAY

ISO9001, ISO/TS16949, ISO14001, OHSAS18001, IECQ QC 080000 CERTIFIED

2017 Rev. 1.00

## ORDERING INFORMATION

Type	HFD41 /12VDC -N S G F 3 (XXX) HFD41A	
Coil voltage	3, 5, 6, 9, 12, 24 VDC	
Coil power	H: 200mW	N: 360mW B: 450mW
Construction <sup>1)2)</sup>	S: Plastic sealed	Nil: Flux proofed
Contact plating	G: Gold plated <sup>3)</sup>	Nil: No gold plated
Insulation standard	F: Class F	Nil: Class B
Contact capacity <sup>3)</sup>	3: 3A (AgCdO, riveted contact) 5: 5A (AgCdO, riveted contact) Nil: 1A, 2A (AgNi, threaded contact)	
Special code <sup>4)</sup>	XXX: Customer special requirement	Nil: Standard

- Notes:** 1) Under the ambience with dangerous gas like H<sub>2</sub>S, SO<sub>2</sub> or NO<sub>2</sub>, plastic sealed type is recommended; Please test the relay in real applications. If the ambience allows, flux proofed type is preferentially recommended.  
 2) Contact is recommended for suitable condition and specifications if water cleaning or surface process is involved in assembling relays on PCB.  
 3) For gold plated type, the min. switching current and min. switching voltage is 10mA 5VDC. For 3A, 5A load products, only gold-plated contact is available.  
 4) The customer special requirement express as special code after evaluating by Hongfa.

## OUTLINE DIMENSIONS, WIRING DIAGRAM AND PC BOARD LAYOUT

Unit: mm

### Outline Dimensions

HFD41

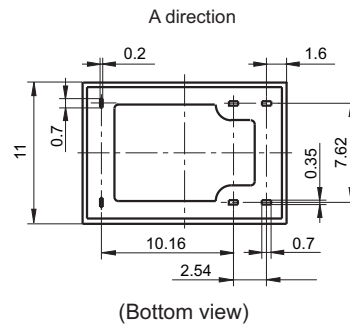
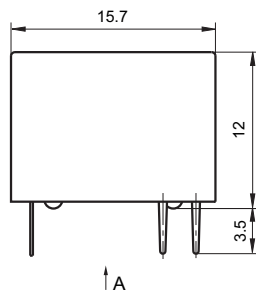

Wiring Diagram  
(Bottom view)

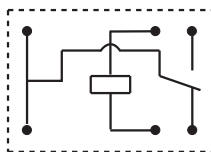

PCB Layout  
(Bottom view)

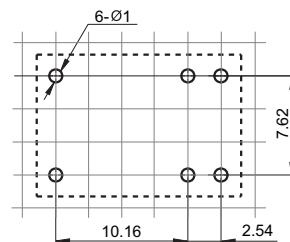

HFD41A

**Outline Dimensions**

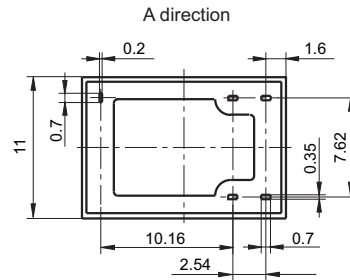
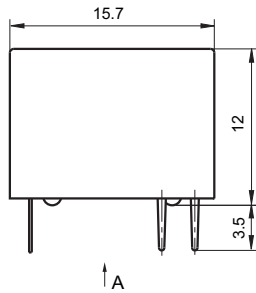

(Bottom view)

**Wiring Diagram  
(Bottom view)**

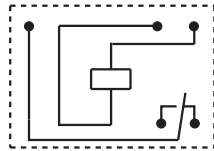

**PCB Layout  
(Bottom view)**

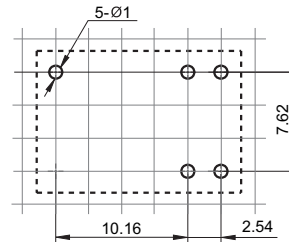

- Remark: 1) In case of no tolerance shown in outline dimension: outline dimension  $\leq 1\text{mm}$ , tolerance should be  $\pm 0.2\text{mm}$ ; outline dimension  $> 1\text{mm}$  and  $\leq 5\text{mm}$ , tolerance should be  $\pm 0.3\text{mm}$ ; outline dimension  $> 5\text{mm}$ , tolerance should be  $\pm 0.4\text{mm}$ .  
 2) The tolerance without indicating for PCB layout is always  $\pm 0.1\text{mm}$ .  
 3) The width of the gridding is 2.54mm.

**CHARACTERISTIC CURVES**

**ENDURANCE CURVE**

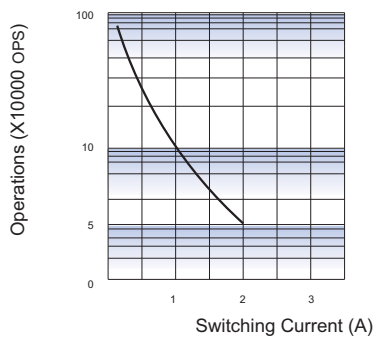

**COIL TEMPERATURE RISE**

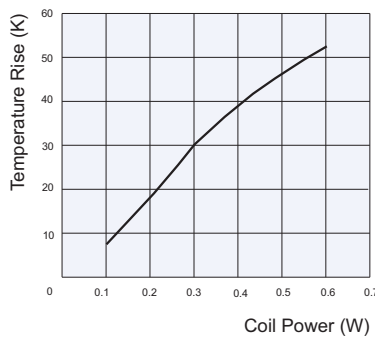

**OPERATE TIME**

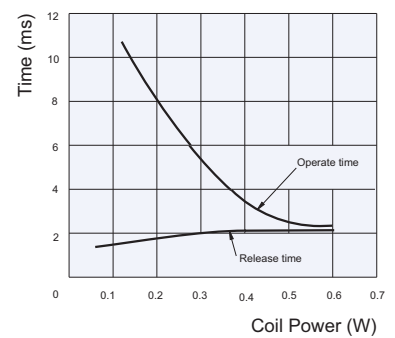

**Test conditions:**

Resistive load, Room temp., 1s on 9s off.

**Disclaimer**

The specification is for reference only. See to "Terminology and Guidelines" for more information. Specifications subject to change without notice. We could not evaluate all the performance and all the parameters for every possible application. Thus the user should be in a right position to choose the suitable product for their own application. If there is any query, please contact Hongfa for the technical service. However, it is the user's responsibility to determine which product should be used only.