

**T92 Series Two-pole 30A PCB or Panel Mount Relay**

- 40A, 2 form A (NO) and 2 form C (CO) switching capability
- Designed to control compressor loads to 3.5 tons, 110LRA / 25.3FLA
- Meets requirements of UL 508 and UL 873 spacings - 8mm through air, 9.5mm over surface
- Meets requirements of VDE 8mm spacing, 4kV dielectric coil-to-contact
- Meets requirements of UL Class F construction
- UL approved for 600VAC switching (1.5HP)
- New screw terminal version (consult factory for availability, ratings)

Typical applications  
HVAC, residential / commercial appliances, industrial controls.

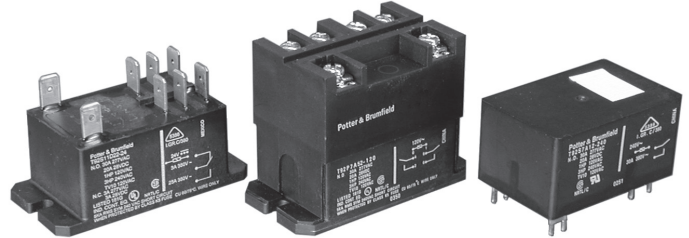

**Approvals**

UL E58304 (Recognized and Listed); CSA LR48471; VDE 40019600  
Technical data of approved types on request.

**Contact Data**

Contact arrangement	2 form A (NO); 2 form C (CO)
Rated voltage	277VAC
Max. switching voltage	600VAC
Rated current	30A NO; 3A NC
Limiting continuous current	40A NO; 3A NC
Limiting making current	40A NO; 3A NC
Limiting breaking current	40A NO; 3A NC
Contact material	AgSnInO, AgCdO
Min. recommended contact load	500ma (NO)/ 100ma (NC), 12VAC
Frequency of operation, with load	360hr
Operate/release time max., including bounce	25/25ms

**Contact ratings <sup>1)</sup>**

Type	Load	Cycles
<b>UL508</b>		
AgCdO		
NO	40A, 277VAC, resistive	6x10 <sup>3</sup>
NO	30A, 120/277VAC, resistive	100x10 <sup>3</sup>
NO	10A, 600VAC, general purpose	100x10 <sup>3</sup>
NO	1HP, 120VAC	100x10 <sup>3</sup>
NO	3HP, 240VAC	1x10 <sup>3</sup>
NO	1.5HP, 480 or 600VAC	100x10 <sup>3</sup>
NO	110LRA/25.3FLA, 240VAC (DC coil only)	100x10 <sup>3</sup>
NO	60LRA/14FLA, 240VAC (AC coil only)	100x10 <sup>3</sup>
NO	3A, 240VAC, pilot duty	100x10 <sup>3</sup>
NO	20A, 28VDC, resistive	100x10 <sup>3</sup>
NO	TV10, 120VAC	100x10 <sup>3</sup>
NC	3A, 277VAC	100x10 <sup>3</sup>
NC	2A, 480VAC	100x10 <sup>3</sup>
NC	1A, 600VAC	100x10 <sup>3</sup>
AgSnInO		
NO	30A, 120/277VAC, resistive (DC coil only)	200x10 <sup>3</sup>
NO	30A, 120/277VAC, resistive (AC coil only)	100x10 <sup>3</sup>
NO	20A, 480VAC, resistive	100x10 <sup>3</sup>
NO	1.5HP, 120VAC, 2 pole making/breaking (Fig.1)	100x10 <sup>3</sup>
NO	3HP, 240VAC, 3 phase (DC coil only)	100x10 <sup>3</sup>
NO	3HP, 480VAC, 3 phase (DC coil only)	100x10 <sup>3</sup>
NO	2HP, 600VAC, 3 phase (DC coil only)	100x10 <sup>3</sup>
<b>VDE</b>		
AgCdO, flange mount relays		
NO	20A, 400VAC	100x10 <sup>3</sup>
NC	3A, 400VAC	30x10 <sup>3</sup>
CO	20A NO / 3A NC, 400VAC	30x10 <sup>3</sup>
AgCdO, PC mount relays		
NO	30A, 400VAC	100x10 <sup>3</sup>
NC	3A, 400VAC	30x10 <sup>3</sup>
CO	30A NO / 3A NC, 400VAC	30x10 <sup>3</sup>

**Contact ratings <sup>1)</sup> (continued)**

ARI 780-86 Endurance Test (section 6.6):  
HVAC Definite Purpose Contactor Standard  
Normally Open Contacts  
Single Phase/Two Pole (Both poles together switching a single load)  
110 LRA, 25.3 FLA, 200K operations (DC Coil)

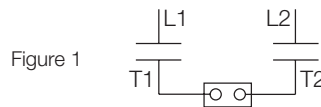

Single Phase Per Pole (Single load per pole)  
110 LRA, 18 FLA, 200K operations (DC Coil).  
60 LRA, 14 FLA, 200K operations (AC Coil).

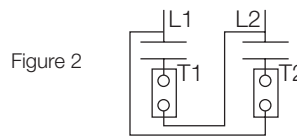

<sup>1)</sup> Contact ratings at 25°C (unless otherwise noted) with relay properly vented.  
FLA, LRA ratings are compatible with 3.5 ton compressor applications.

Mechanical endurance	10x10 <sup>6</sup> ops.
----------------------	-------------------------

**Coil Data**

Coil voltage range	5 to 110VDC; 12 to 240VAC
Max. coil power	1.7W; 4.0VA
Max. coil temperature	155°C
Coil insulation system according UL	Class F

**Coil versions, DC coil**

Coil code	Rated voltage VDC	Operate voltage VDC	Release voltage VDC	Coil resistance Ω±10%	Rated coil power W
6	6	4.5	0.6	22	1.7
9	9	6.75	0.9	48	1.7
12	12	9	1.2	86	1.7
18	18	13.5	1.8	197	1.7
24	24	18	2.4	350	1.7
48	48	36	4.8	1390	1.7
110	110	82.5	11	7255	1.7

**Coil versions, AC coil**

Coil code	Rated voltage VAC	Frequency Hz	Operate voltage VAC, 60Hz	Release voltage VAC, 60Hz	Coil resistance Ω±10%	Rated coil power VA
12	12	60	9.6	1.2	9.1	4
24	24	60	19.2	2.4	36.6	4
120	110/120	50/60	96	12	950	4
240	220/240	50/60	192	24	3800	4
277	250/277	50/60	222	28	5485	4

All figures are given for coil without preenergization, at ambient temperature +23°C.

**T92 Series Two-pole 30A PCB or Panel Mount Relay (Continued)**

**Coil Data (continued)**

**Ambient temperature vs. coil voltage**

Assumptions:

1. Thermal resistance = 35°C per Watt (DC only.)
2. Still air.
3. Nominal coil resistance.
4. Max. mean coil temperature = 155°C (change of resistance method).
5. Coil temperature rise due to load = 6.3°C @ 30 amps.
6. Curves are based on 1.7W at 25°C (DC only.).

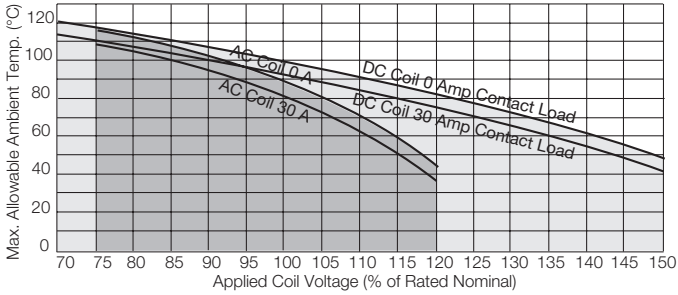

**Insulation Data**

Initial dielectric strength	
between open contacts	1500V <sub>rms</sub>
between contact and coil	4000V <sub>rms</sub>
between adjacent contact	2000V <sub>rms</sub>
Initial surge withstand voltage	
between contact and coil	6kV
Initial insulation resistance	
between insulated elements	1x10 <sup>9</sup> Ω
Clearance/creepage	
between contact and coil	8mm clearance/9.5mm creepage

**Other Data**

Material compliance: EU RoHS/ELV, China RoHS, REACH, Halogen content refer to the Product Compliance Support Center at [www.te.com/customer-support/rohssupportcenter](http://www.te.com/customer-support/rohssupportcenter)

Ambient temperature	
DC coil	-55°C to 85°C
AC coil	-55°C to 65°C
Category of environmental protection	IEC 61810
	RTI - dust protected, RTII - flux proof, RTIII - wash tight
Vibration resistance (functional)	1.65mm max excursions, 10-55 Hz
Shock resistance (functional)	10g for 11msec
Shock resistance (destructive)	100g
Terminal type	PCB-tht or quick connect
Weight	86g
Resistance to soldering heat THT	
IEC 60068-2-20	250°C
Packaging/unit	tray/30 pcs., box/120 pcs.

**Dimensions**

T92 – Mounting and termination code 1



T92 – Mounting and termination code 2, 3 and 4



**T92 Series Two-pole 30A PCB or Panel Mount Relay** (Continued)

**Dimensions**

T92 – Mounting and termination code 5

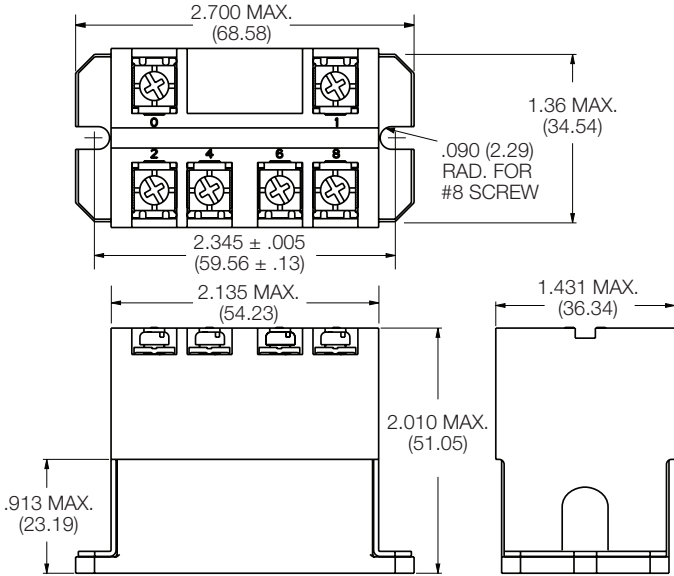

**Terminal assignment**

Bottom view on pins

2 form A

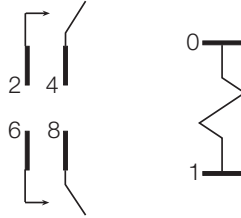

2 form C

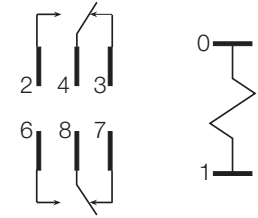

**PCB layout**

Bottom view on pins

T92 - Mounting and termination code 1

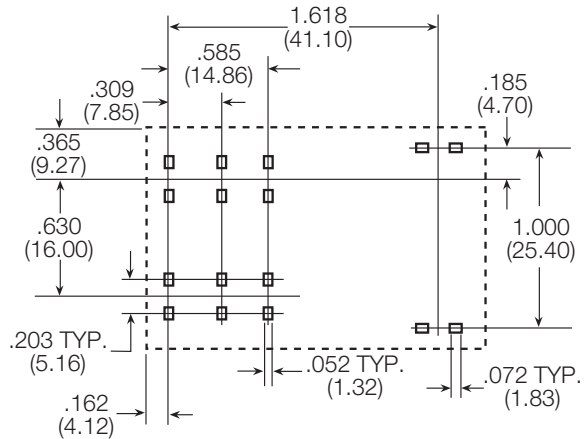

An alternate PCB layout utilizes .076 ± .003 (1.93 ± .076) diameter holes on the same center-to-center spacing shown above. Use of the rectangular holes is recommended for improved solderability.

Only necessary terminals are present on single throw models. Consequently, some holes will be unnecessary for single throw models.

**Product code structure**

Typical product code: **T92 S 11 D 2 2 -24**

**Type** T92 Printed circuit board / panel mount power relay T92

**Enclosure**

- P Dust protected plastic case
- S Wash-tight, tape sealed, plastic case (Mounting and termination code 1)  
Top sealed, not wash-tight, not tape sealed on bottom (Mounting and termination codes 2, 3 & 4)

**Contact arrangement**

- 7 2 form A (2 NO)
- 11 2 form C (2 CO)

**Coil Input**

- A AC voltage, 60Hz or 50/60 Hz (consult coil versions table)
- D DC voltage

**Mounting and termination**

- 1 Printed circuit board mount; printed circuit board terminals.
- 2 Panel mount via flanged cover; .250" (6.35mm) x .032" (.81mm) QC terminal
- 3 Panel mount via flanged cover; .187" (4.75mm) x .032" (.81mm) QC terminals for coil and .250" (6.35mm) for contacts
- 4 Panel mount via flanged cover; .187" (4.75mm) x .020" (.51mm) QC terminals for coil and .250" (6.35mm) for contacts.
- 5 Panel mount via flanged cover, M4 screws w/ captive pressure plates. Requires Enclosure P and Contact arrangement 7.

**Contact material**

- 2 AgCdO
- 4 AgSnOInO

**Coil voltage**  
Coil code: please refer to coil versions table

**T92 Series Two-pole 30A PCB or Panel Mount Relay** (Continued)

Product Code	Enclosure	Contacts	Coil	Mounting	Contact Material	Coil	Part Number					
T92P7A22-24	Plastic dust cover	2 form A, 2 NO	AC	Panel mount + quick connect	AgCdO	24 VAC	6-1393211-0					
T92P7A22-120						120 VAC	5-1393211-7					
T92P7A22-240						240 VAC	6-1393211-2					
T92P7A22-277						277 VAC	6-1393211-3					
T92P7A24-240				Panel mount + screw terminals	AgSnOInO	240 VAC	3-1423008-3					
T92P7A52-120						120 VAC	1423008-8					
T92P7A52-240						240 VAC	1-1423008-2					
T92P7D12-12						12 VDC	6-1393211-5					
T92P7D12-24			DC	PCB terminals		24 VDC	6-1393211-6					
T92P7D22-12						12VDC	6-1393211-9					
T92P7D22-24						24 VDC	7-1393211-1					
T92P7D22-48						48 VDC	7-1393211-2					
T92P7D24-12					AgSnOInO	12VDC	2-1423008-2					
T92P7D24-24						24 VDC	1423008-9					
T92P7D42-24						AgCdO	7-1393211-5					
T92P7D52-12							12 VDC	1-1423008-0				
T92P7D52-24		2 form C, 2 CO	AC	Panel mount + screw terminals		24 VDC	1423967-1					
T92P11A12-120						120 VAC	3-1393211-8					
T92P11A22-12						12 VAC	3-1393211-9					
T92P11A22-24						24 VAC	4-1393211-3					
T92P11A22-120						120 VAC	4-1393211-0					
T92P11A22-240						240 VAC	4-1393211-4					
T92P11A22-277						277 VAC	4-1393211-6					
T92P11A24-240						240 VAC	3-1423008-7					
T92P11A42-120					AgSnOInO	120VAC	4-1393211-8					
T92P11D12-12						AgCdO	5-1393211-0					
T92P11D12-12							12 VDC	5-1393211-3				
T92P11D22-12						24 VDC	5-1393211-4					
T92P11D24-12			DC	PCB terminals		12 VDC	3-1423008-5					
T92P11D24-12						12 VDC	3-1423008-6					
T92P11D24-24						24 VDC	3-1423008-6					
T92S7A12-24						Wash tight	2 form A, 2 NO	AC	PCB terminals	AgCdO	24 VAC	9-1393211-8
T92S7A12-120	120 VAC	9-1393211-7										
T92S7A12-240	240 VAC	9-1393211-9										
T92S7A22-24	Top sealed			Panel mount + quick connect		24 VAC	1393212-4					
T92S7A22-120						120 VAC	1393212-2					
T92S7A22-240						240 VAC	1393212-5					
T92S7D12-12	Wash tight		DC	PCB terminals		12 VDC	1393212-8					
T92S7D12-24						24 VDC	1-1393212-0					
T92S7D12-48						48 VDC	1-1393212-1					
T92S7D12-110						110 VDC	1393212-7					
T92S7D14-24					AgSnOInO	24 VDC	1-1423008-8					
T92S7D22-12						AgCdO	1-1393212-4					
T92S7D22-18							18 VDC	1-1393212-5				
T92S7D22-24						24 VDC	1-1393212-7					
T92S7D22-110						110 VDC	1-1393212-3					
T92S11A12-24						Wash tight	2 form C, 2 CO	AC	PCB terminals		24 VAC	8-1393211-1
T92S11A12-120											120 VAC	8-1393211-0
T92S11A12-240											240 VAC	8-1393211-2
T92S11A22-12	Top sealed			Panel mount + quick connect		12 VAC	8-1393211-3					
T92S11A22-24						24 VAC	8-1393211-6					
T92S11A22-120						120 VAC	8-1393211-4					
T92S11A22-240						240 VAC	8-1393211-7					
T92S11D12-12	Wash tight		DC	PCB terminals		12 VDC	8-1393211-9					
T92S11D12-24						24 VDC	9-1393211-0					
T92S11D12-48						48 VDC	9-1393211-1					
T92S11D12-110						110 VDC	8-1393211-8					
T92S11D22-12	Top sealed			Panel mount + quick connect		12 VDC	9-1393211-3					
T92S11D22-24						24 VDC	9-1393211-4					